

This instrument prepared by, or under the supervision of (and after recording, return to):

James E. Albertelli, Esq.  
Albertelli & Associates, P.L.  
5200 Belfort Road  
Suite 250  
Jacksonville, Florida 32256

(Reserved for Clerk of Court)

**DECLARATION  
OF  
MONTEREY AT BEACH BOULEVARD, A CONDOMINIUM**

**Monterey Capital Partners, LLC, a Florida limited liability company** hereby declares:

1. Introduction and Submission.
  - 1.1 The Land. The Developer is the owner of that certain land, located in Duval County, Florida, as more particularly described in **Exhibit "1"** attached hereto (the "Land").
  - 1.2 Submission Statement. Except as set forth in this Subsection, the Developer hereby submits the Land and all improvements erected or to be erected thereon, and all other property, real, personal or mixed, now or hereafter situated on or within the Land - but excluding all public or private (e.g. cable television and/or other receiving or transmitting lines, fiber, antennae or equipment) utility installations therein or thereon, and all leased property therein or thereon - to the condominium form of ownership and use in the manner provided for in the Florida Condominium Act pursuant to Chapter 718, Florida Statutes, as it exists on the date hereof. Without limiting any of the foregoing, no property, real, personal or mixed, not located within or upon the Land as aforesaid shall for any purposes be deemed part of the Condominium or be subject to the jurisdiction of the Association, the operation and effect of the Florida Condominium Act or any rules or regulations promulgated pursuant thereto, unless expressly provided.
  - 1.3 Name. The name by which this condominium is to be identified is **MONTEREY AT BEACH BOULEVARD, A CONDOMINIUM** (hereinafter called the "Condominium").
2. Definitions. For all purposes in this Declaration and in its exhibits, and for all purposes in the Articles of Incorporation and Bylaws of **MONTEREY AT BEACH BOULEVARD CONDOMINIUM ASSOCIATION, INC.**, a Florida corporation not for profit (the "Association") and as it and they may hereafter be amended, the following words shall have the respective meanings ascribed to them in this Section, except where the context clearly indicates a different meaning:
  - 2.1 "Act" means the Florida Condominium Act (Chapter 718 of the Florida Statutes) as it exists on the date hereof and as it may be hereafter renumbered.
  - 2.2 "Articles" or "Articles of Incorporation" mean the Articles of Incorporation of the Association, as amended from time to time.
  - 2.3 "Assessment" means a share of the funds required for the payment of Common Expenses which from time to time is assessed against the Unit Owner.
  - 2.4 "Association" or "Condominium Association" means **MONTEREY AT BEACH BOULEVARD CONDOMINIUM ASSOCIATION, INC.**, a Florida corporation not for profit, the sole entity responsible for the operation of the Condominium.
  - 2.5 "Association Property" means that property, real and personal, which is owned or leased by, or is dedicated by a recorded plat to, the Association for the use and benefit of its members.
  - 2.6 "Board" or "Board of Directors" means the board of directors, from time to time, of the Association.
  - 2.7 "Building" means the structure(s) in which the Units and the Common Elements are located, regardless of the number of such structures, which are located on the Condominium Property.
  - 2.8 "By-Laws" mean the By-Laws of the Association, as amended from time to time.
  - 2.9 "City" means the City of Jacksonville, located within the County of Duval and the State of Florida.

(Reserved for Clerk of Court)

- 2.10 "Committee" means a group of Board Members, Unit Owners or Board Members and Unit Owners appointed by the Board or a member of the Board to make recommendations to the Board regarding the proposed annual budget or to take action on behalf of the Board.
- 2.11 "Common Elements" mean and include:
- (a) The portions of the Condominium Property which are not included within either the Units and/or the Association Property.
  - (b) All structural columns and bearing walls regardless of where located.
  - (c) Easements through Units for conduits, ducts, plumbing, wiring and other facilities for the furnishing of utility and other services to Units, Common Elements and/or the Association Property.
  - (d) An easement of support in every portion of a Unit which contributes to the support of the Building.
  - (e) The property and installations required for the furnishing of utilities and other services to more than one Unit or to the Common Elements or to the Association Property.
  - (f) Any other parts of the Condominium Property designated as Common Elements in this Declaration.
  - (g) Any and all portions of the Life Safety Systems (as hereinafter defined), regardless of where located within the Condominium Property.
- 2.12 "Common Expenses" mean all expenses incurred by the Association for the operation, management, maintenance, repair, replacement or protection of the Common Elements and Association Property, the costs of carrying out the powers and duties of the Association, and any other expense, whether or not included in the foregoing, designated as a "Common Expense" by the Act, the Declaration, the Articles or the Bylaws. For all purposes of this Declaration, "Common Expenses" shall also include, without limitation: (a) all reserves required by the Act or otherwise established by the Association, regardless of when reserve funds are expended; (b) the cost of a master antenna television system or cable or satellite television service obtained pursuant to a bulk contract; (c) the cost of any bulk contract for broadband, telecommunications, satellite and/or internet services, if any, (d) if applicable, costs relating to reasonable transportation services, road maintenance and operation expenses, management, administrative, professional and consulting fees and expenses, in-house and/or interactive communications and surveillance systems; (e) the real property taxes, Assessments and other maintenance expenses attributable to any Units acquired by the Association or any Association Property; (f) all expense of installation, repair, and maintenance of hurricane shutters by the Board (provided, however, that a Unit Owner who has already installed hurricane shutters (or other acceptable hurricane protection) shall receive a credit equal to the pro rata portion of the assessed installation cost assigned to each Unit, but shall not be excused from any portion of expenses related to maintenance, repair, replacement or operation of same); (g) any lease or maintenance agreement payments required under leases or maintenance agreements for mechanical or other equipment, including without limitation, leases for recycling equipment, if same is leased by the Association rather than being owned by it; (h) all expenses related to the installation, repair, maintenance, operation, alteration and/or replacement of Life Safety Systems (as hereinafter defined); (i) any and all payments required under any service, management and/or maintenance agreements for the operation of, or services provided to, the Condominium Property (j) any unpaid share of Common Expenses or Assessments extinguished by foreclosure of a superior lien or by deed in lieu of foreclosure; (k) costs of fire, windstorm, flood, liability and all other types of insurance including, without limitation, and specifically, insurance for officers and directors of the Association; (l) costs of water and sewer, electricity, gas and other utilities which are not consumed by and metered to individual Units; and (m) costs resulting from damage to the Condominium Property which are necessary to satisfy any deductible and/or to effect necessary repairs which are in excess of insurance proceeds received as a result of such damage.
- 2.13 "Common Facilities or Association Property" means any real property or improvements thereon owned by the Association for the use and benefit of the Unit Owners.

(Reserved for Clerk of Court)

- 2.14 "Common Surplus" means the amount of all receipts or revenues, including assessments, rents or profits, collected by the Condominium Association which exceeds Common Expenses.
- 2.15 "Condominium" shall have the meaning given to it in Subsection 1.3 above.
- 2.16 "Condominium Act" means Chapter 718, Florida Statutes, as it exists on the date hereof, which is incorporated herein by reference. All provisions thereof shall apply to this Condominium.
- 2.17 "Condominium Form of Ownership" means that form of ownership of real property created pursuant to the provisions of Chapter 718, Florida Statutes, the "Condominium Act", and which is composed of Condominium Units that may be owned by one or more persons, and appurtenant to each Condominium Unit, an undivided share in the Common Elements.
- 2.18 "Condominium Parcel" means a Unit together with the Limited Common Elements appurtenant to it and the undivided share in the Common Elements which is appurtenant to said Unit; and when the context permits, the term includes all other appurtenances to the Unit.
- 2.19 "Condominium Property" means the Land, Improvements and other property described in Subsection 1.2 hereof, subject to the limitations thereof and exclusions therefrom.
- 2.20 "Condominium Unit or Unit" means that part of the Condominium Property which is subject to exclusive ownership.
- 2.21 "County" means the County of Duval, State of Florida.
- 2.22 "Declaration" or "Declaration of Condominium" means this instrument and all exhibits attached hereto, as same may be amended from time to time.
- 2.23 "Developer" means **Monterey Capital Partners, LLC, a Florida limited liability company**, its successors, nominees, affiliates and such of its assigns as to which the rights of Developer hereunder are specifically assigned. Developer may assign all or a portion of its rights hereunder, or all or a portion of such rights in connection with specific portions of the Condominium. In the event of any partial assignment, the assignee shall not be deemed the Developer, but may exercise such rights of Developer as are specifically assigned to it. Any such assignment may be made on a nonexclusive basis. Notwithstanding any assignment of the Developer's rights hereunder (whether partially or in full), the assignee shall not be deemed to have assumed any of the obligations of the Developer unless, and only to the extent that, it expressly agrees to do so in writing. Any such assignment may be made on a non-exclusive basis. The rights of Developer under this Declaration are independent of the Developer's rights to control the Board of Directors of the Association, and, accordingly, shall not be deemed waived, transferred or assigned to the Unit Owners, the Board or the Association upon the transfer of control of the Association. Notwithstanding anything herein contained to the contrary, in any instance where the Developer's consent is required, the Developer may grant or withhold its consent, or if granting (condition such consent), in its sole and absolute discretion.
- 2.24 "Dispute", for purposes of Subsection 18.1, means any disagreement between two or more parties that involves: (n) the authority of the Board, under any law or under this Declaration, the Articles or By-Laws to: (i) require any Owner to take any action, or not to take any action, involving that Owner's Unit or the appurtenances thereto; or (ii) alter or add to a common area or Common Element; or (o) the failure of the Association, when required by law or this Declaration, the Articles or By-Laws to: (i) properly conduct elections; (ii) give adequate notice of meetings or other actions; (iii) properly conduct meetings; or (iv) allow inspection of books and records. "Dispute" shall not include any disagreement that primarily involves title to any Unit or Common Element; the interpretation or enforcement of any warranty; or the levy of a fee or Assessment or the collection of an Assessment levied against a party.
- 2.25 "Division" means the Division of Florida Land Sales, Condominiums and Mobile Homes of the Department of Business and Professional Regulation, State of Florida, or its successor.
- 2.26 "First Mortgagee" shall have the meaning given to it in Subsection 13.6 below.
- 2.27 "Improvements" mean all structures and artificial changes to the natural environment (exclusive of landscaping) located or to be located on the Condominium Property, including, but not limited to, the Building.

(Reserved for Clerk of Court)

- 2.28 "Institutional First Mortgagee" means a bank, savings and loan association, insurance company, mortgage company, real estate or mortgage investment trust, pension fund, an agency of the United States Government, mortgage banker, the Federal National Mortgage Association ("FNMA"), the Federal Home Loan Mortgage Corporation ("FHLMC") or any other lender generally recognized as an institutional lender, or the Developer, holding a first mortgage on a Unit or Units. A "Majority of Institutional First Mortgagees" shall mean and refer to Institutional First Mortgagees of Units to which at least fifty-one percent (51%) of the voting interests of Units subject to mortgages held by Institutional First Mortgagees are appurtenant.
- 2.29 "Insured Property" shall have the meaning given to it in Subsection 14.2(a) below.
- 2.30 "Land" shall have the meaning given to it in Subsection 1.1 above.
- 2.31 "Life Safety Systems" mean and refer to any and all emergency lighting, audio and visual signals, safety systems, sprinklers and smoke detection systems, which are now or hereafter installed in the Building, whether or not within the Units. All such Life Safety Systems, together with all conduits, wiring, electrical connections and systems related thereto, regardless of where located, shall be deemed Common Elements hereunder. Without limiting the generality of the foregoing, when the context shall so allow, the Life Safety Systems shall also be deemed to include all means of emergency ingress and egress, which shall include all stairways and stair landings. Notwithstanding the breadth of the foregoing definition, nothing herein shall be deemed to suggest or imply that the Building or the Condominium contains all such Life Safety Systems.
- 2.32 "Limited Common Elements" mean those Common Elements, the use of which is reserved to a certain Unit or Units, to the exclusion of other Units, as specified in this Declaration. The Limited Common Elements shall include but not be limited to (i) one parking space for each residential Condominium Unit, which are depicted in the Survey and Plot Plan described in Exhibit "2" (ii) any air conditioning and heating system exclusively serving the Condominium Unit which is located outside of the Condominium Unit, which shall be Limited Common Elements for the exclusive use of the Condominium Unit they serve, (iii) the Unit entrance way, patio areas and balconies depicted in the Survey and Plot Plan and any improvements constructed thereon, (iv) those other areas or facilities designated as Limited Common Elements on the Survey, Graphic Description and Plot Plan described in Exhibit "2", and (v) those items described in section 3.3 as Limited Common Elements. Notwithstanding any provision to the contrary, the Developer reserves the right to assign and re-assign handicap spaces to such Unit Owners as Developer determines such parking spaces should be assigned to in the Developer's sole and absolute discretion. A copy of each Certificate or Assignment shall be included in the records of the Association. References herein to Common Elements also shall include all Limited Common Elements unless the context would prohibit or it is otherwise expressly provided.
- 2.33 "Management Agreement" means the agreement, if any, which provides for management of the Condominium Property and the Common Elements.
- 2.34 "Material Amendment" shall have the meaning given to it in Subsection 6.2 below.
- 2.35 "Member" means an owner of fee simple estate in a Condominium Parcel who is a member in the Association.
- 2.36 "Optional Property" shall have the meaning given to it in Subsection 14.5(b) below.
- 2.37 "Primary Institutional First Mortgagee" means the Institutional First Mortgagee which owns, at the relevant time, Unit mortgages securing a greater aggregate indebtedness than is owed to any other Institutional First Mortgagee.
- 2.38 "Unit" means each Condominium Unit as identified and designate as set forth in the Survey, Graphic Description and Plot Plan contained in Exhibit B. Each Condominium Unit consists of (1) the volumes of space enclosed by the unfinished inner surfaces of interior partition walls, ceilings and floors thereof, including vents, doors, windows and such other structural elements as are ordinarily considered to be enclosures of space, (2) all interior dividing walls and partitions (including the space occupied by such interior walls and partitions), excepting load-bearing interior walls and partitions, (3) the decorated inner surfaces of the perimeter and interior walls (including decorated inner surfaces of all interior load-bearing walls), floors and ceilings, consisting of wallpaper, paint, plaster, carpeting, tiles and all other finishing materials affixed or installed as part of the physical structure of the Condominium Unit, (4) regular window panes, patio window panes, sliding glass door panes and other doors bounding the Condominium Unit,

(Reserved for Clerk of Court)

(5) all fixtures, mechanical systems and equipment installed for the sole and exclusive use of the Condominium Unit and (6) any party walls located between two Units which are combined to form a single living residence. Notwithstanding any provision to the contrary, pipes, wires, conduits, or other utility lines or installations constituting a part of the overall systems designed for the service of any particular Condominium Unit, or any of the structural members or portions of any kind, including fixtures and appliances and stairways within the Condominium Unit, which are not removable without jeopardizing the soundness, safety or usefulness of the remainder of the Building or another Condominium Unit, shall not be deemed to be part of any Condominium Unit.

2.39 "Unit Owner" or "Owner of a Unit", or "Owner" means a record owner of legal title to a Condominium Parcel.

2.40 "Voting Interest" means the voting rights distributed to the members of the Association.

### 3. Description of Condominium.

3.1 Identification of Units. The Land has constructed thereon Nineteen (19) Buildings, said buildings contain in the aggregate two-hundred nineteen (219) residential Units. Each such Unit is identified by a separate numerical and/or alpha-numerical designation. The designation of each of such Units is set forth on **Exhibit "2"** attached hereto. Exhibit "2" consists of a survey of the Land, a graphic description of the Improvements located thereon, including, but not limited to, the Building in which the Units are located, and a plot plan thereof. Said Exhibit "2", together with this Declaration, is sufficient in detail to identify the Common Elements and each Unit and their relative locations and dimensions. There shall pass with a Unit, owned in fee simple, as appurtenances thereto: (a) an undivided share in the Common Elements and Common Surplus; (b) the exclusive right to use such portion of the Common Elements as may be provided in this Declaration, including, without limitation, the right to transfer such right to other Units or Unit Owners; (c) an exclusive easement for the use of the airspace occupied by the Unit as it exists at any particular time and as the Unit may lawfully be altered or reconstructed from time to time, provided that an easement in airspace which is vacated shall be terminated automatically; (d) membership in the Association with the full voting rights appurtenant thereto; and (e) other appurtenances as may be provided by this Declaration.

3.2 Unit Boundaries. Each Unit shall include that part of the Building containing the Unit that lies within the following boundaries:

(a) Upper and Lower Boundaries. The upper and lower boundaries of the Unit shall be the following boundaries extended to their planar intersections with the perimetrical boundaries:

(i) Upper Boundaries. The horizontal plane of the unfinished lower surface of the ceiling (which will be deemed to be the ceiling of the upper story if the Unit is a multi-story Unit, provided that in multi-story Units where the lower boundary extends beyond the upper boundary, the upper boundary shall include that portion of the ceiling of the lower floor for which there is no corresponding ceiling on the upper floor directly above such bottom floor ceiling).

(ii) Lower Boundaries. The horizontal plane of the unfinished upper surface of the floor of the Unit (which will be deemed to be the floor of the first story if the Unit is a multi-story Unit, provided that in multi-story Units where the upper boundary extends beyond the lower boundary, the lower boundary shall include that portion of the ceiling of the upper floor for which there is no corresponding ceiling on the bottom floor directly below the floor of such top floor).

(iii) Interior Divisions. Except as provided in Subsections 3.2(a)(i) and 3.2(a)(ii) above, no part of the floor of the top floor, ceiling of the bottom floor, stairwell adjoining the multi-floors, in all cases of a multi-story Unit, if any, or nonstructural interior walls shall be considered a boundary of the Unit.

(b) Perimetrical Boundaries. The perimetrical boundaries of the Unit shall be the vertical planes of the unfinished interior surfaces of the walls bounding the Unit extended to their planar intersections with each other and with the upper and lower boundaries.

(Reserved for Clerk of Court)

- (c) Apertures. Where there are apertures in any boundary, including, but not limited to, doors and skylights, such boundaries shall be extended to include the doors and other fixtures located in such apertures, excluding windows, but including all frameworks, window casings and weather stripping thereof, together with exterior surfaces made of glass or other transparent materials; provided, however, that the exteriors of doors facing interior Common Element hallways shall not be included in the boundaries of the Unit and shall therefore be Common Elements. Notwithstanding anything herein contained to the contrary, any elevators (including all mechanical equipment serving, and housing for the elevators) solely serving a Unit (to the exclusion of all other Units) shall be deemed part of the Unit. Further, notwithstanding anything to the contrary, the structural components of the Building are expressly excluded from the Units and are instead deemed Common Elements. Lastly, notwithstanding anything to the contrary, the structural components of the Building and the Life Safety Systems, regardless where located, are expressly excluded from the Units and are instead deemed Common Elements.
- (d) Exceptions. In cases not specifically covered above, and/or in any case of conflict or ambiguity, the survey of the Units set forth as Exhibit "2" hereto shall control in determining the boundaries of a Unit, except that the provisions of Subsection 3.2(c) above shall control unless specifically depicted and labeled otherwise on such survey.

3.3 Limited Common Elements. Each Unit may have, to the extent applicable and subject to the provisions of this Declaration, as Limited Common Elements appurtenant thereto:

- (a) Patios, Balconies, Courtyards, Lanais and Terraces. Any patio, balcony, courtyard, terrace and/or lanai (and all improvements thereto) as to which direct and exclusive access shall be afforded to any particular Unit or Units to the exclusion of others shall be a Limited Common Element of such Unit(s). The Association shall be responsible for the maintenance of the structural and mechanical elements of any such Limited Common Elements, with the costs of same being a part of the Common Expenses. Each Unit Owner shall, however, be responsible for the maintenance of any other portions of such areas, for the general cleaning, plant care and upkeep of the appearance of the area(s) and for the repair and replacement of any floor coverings placed or installed on any patio, balcony, courtyard, terrace and/or lanai. A Unit Owner using a patio, balcony, courtyard, terrace and/or lanai or making or causing to be made any additions, alterations or improvements thereto agrees, and shall be deemed to have agreed, for such Owner, and his or her heirs, personal representatives, successors and assigns, as appropriate, to hold the Association, the Developer, and all other Unit Owners harmless from and to indemnify them for any liability or damage to the Condominium and/or Association Property and expenses arising therefrom.
- (b) Parking Spaces and/or Parking Garages. Each parking space and/or private parking garage shown on Exhibit "2" attached hereto shall be a Limited Common Element only upon it being assigned as such to a particular Unit in the manner described herein. Developer, or the Association through its Board subsequent to turnover, hereby reserves the right to assign, with or without consideration, the exclusive right to use any parking space and/or parking garage located within the Common Elements of the Condominium to one or more Units, whereupon the space and/or garage so assigned shall be deemed a Limited Common Element of the Unit(s) to which it is assigned. Such assignment shall not be recorded in the Public Records of the County but, rather, shall be made by way of instrument placed in the official records of the Association (as same are defined in the By-Laws). Further, a Limited Common Element parking space and/or parking garage may be relocated at any time, and from time to time, by the Board to comply with applicable Federal, State and local laws and regulations regarding or affecting handicap accessibility. A Unit Owner may assign the Limited Common Element parking space and/or parking garage appurtenant to his or her Unit to another Unit by written instrument delivered to (and to be held by) the Association. As to any Limited Common Element parking space and/or parking garage which was originally assigned by the Developer, the Developer reserves the right, at any time provided that the Developer owns a Unit, to reassign such parking space and/or parking garage. The maintenance of any parking space and/or parking garage so assigned shall be the responsibility of the Association. **EACH UNIT OWNER ACKNOWLEDGES AND AGREES THAT CERTAIN OF THE PARKING SPACES AND/OR PARKING GARAGES MAY BE LOCATED BELOW THE FEDERAL FLOOD PLAIN, AND, ACCORDINGLY, IN THE EVENT OF FLOODING, ANY PERSONAL PROPERTY STORED THEREIN IS**

(Reserved for Clerk of Court)

**SUSCEPTIBLE TO WATER DAMAGE. ADDITIONALLY, INSURANCE PREMIUMS, BOTH FOR THE ASSOCIATION IN INSURING THE PARKING SPACES AND/OR PARKING GARAGES, AND FOR OWNERS, MAY BE HIGHER THAN IF THE AREAS WERE ABOVE THE FEDERAL FLOOD PLAIN. BY ACCEPTING THE ASSIGNMENT OF A PARKING SPACE AND/OR PARKING GARAGE, EACH OWNER, FOR SUCH OWNER AND THE OWNER'S TENANTS, GUESTS AND INVITEES, HEREBY EXPRESSLY ASSUMES ANY RESPONSIBILITY FOR LOSS, DAMAGE OR LIABILITY RESULTING THEREFROM.**

- (c) Storage Spaces. Developer hereby reserves the right to assign, with or without consideration, the exclusive right to use any storage space located within the Common Elements of the Condominium, if any, to one or more Units, whereupon the space so assigned shall be deemed a Limited Common Element of the Unit(s) to which it is assigned. Such assignment shall not be recorded in the Public Records of the County but, rather, shall be made by way of instrument placed in the official records of the Association (as same are defined in the By-Laws). After assignment to a Unit by the Developer, a Unit Owner may reassign the Limited Common Element storage space appurtenant to his Unit to another Unit by written instrument delivered to (and to be held by) the Association. The maintenance of any space so assigned, the fencing of such space, as well as the insurance of its contents, shall be the sole responsibility of the Owner of the Unit(s) to which it is assigned. EACH UNIT OWNER ACKNOWLEDGES AND AGREES THAT CERTAIN OF THE STORAGE AREAS MAY BE LOCATED BELOW THE FEDERAL FLOOD PLAIN, AND, ACCORDINGLY, IN THE EVENT OF FLOODING, ANY PERSONAL PROPERTY STORED THEREIN IS SUSCEPTIBLE TO WATER DAMAGE. ADDITIONALLY, INSURANCE PREMIUMS, BOTH FOR THE ASSOCIATION IN INSURING THE STORAGE AREAS, AND FOR OWNERS, MAY BE HIGHER THAN IF THE AREAS WERE ABOVE THE FEDERAL FLOOD PLAIN. BY ACCEPTING THE ASSIGNMENT OF A STORAGE LOCKER, EACH OWNER, FOR SUCH OWNER AND THE OWNER'S TENANTS, GUESTS AND INVITEES, HEREBY EXPRESSLY ASSUMES ANY RESPONSIBILITY FOR LOSS, DAMAGE OR LIABILITY RESULTING THEREFROM.
- (d) Miscellaneous Areas, Equipment. Any fixtures or equipment (e.g., an air conditioning compressor, other portions of any air conditioning systems or hot water heater) serving a Unit or Units exclusively and any area (e.g., a closet, ground slab or roof surface) upon/within which such fixtures or equipment are located shall be Limited Common Elements of such Unit(s). Without limiting the foregoing, each air conditioning unit (and all equipment and fixtures constituting an individual air conditioning system) located on the roof of a Building which serves one Unit shall be deemed a Limited Common Element of the Unit it serves. The maintenance of any such equipment and/or areas so assigned shall be the sole responsibility of the Owner of the Unit(s) to which it is appurtenant.
- (e) Other. If applicable, any other portion of the Common Elements which, by its nature, cannot serve all Units but serves one Unit or more than one Unit (i.e., any hallway and/or elevator landing serving a single Unit or more than one (1) Unit owned by the same Owner) shall be deemed a Limited Common Element of the Unit(s) served and shall be maintained by said Owner. In the event of any doubt or dispute as to whether any portion of the Common Elements constitutes a Limited Common Element or in the event of any question as to which Units are served thereby, a decision shall be made by a majority vote of the Board of Directors of the Association and shall be binding and conclusive when so made. To the extent of any area deemed a Limited Common Element under this Subsection 3.3(e), the Owner of the Unit (s) to which the Limited Common Element is appurtenant shall have the right to alter same, in accordance with 3.3(a), as if the Limited Common Element were part of the Owner's Unit, rather than as required for alteration of Common Elements. Notwithstanding the foregoing, the designation of any portion of the Common Elements as a Limited Common Element under this Subsection 3.3(e) shall not allow the Owner of the Unit to which the Limited Common Element is appurtenant to preclude, or in any way interfere with the passage through such areas as may be needed from time to time for emergency ingress and egress, and for the maintenance, repair, replacement, alteration and/or operation of the elevators, Life Safety Systems, mechanical equipment and/or other Common Elements which are most conveniently

(Reserved for Clerk of Court)

serviced (in the sole determination of the Board) by accessing such areas (and an easement is hereby reserved for such purposes).

3.4 Easements. The following easements are hereby created (in addition to any easements created under the Act and any easements affecting the Condominium Property and recorded in the Public Records of the County):

- (a) Support. Each Unit, the Building and the Improvements shall have an easement of support and of necessity and shall be subject to an easement of support and necessity in favor of all other Units, the Common Elements, and/or the Association Property and any other structure or improvement which abuts any Unit, the Building or any Improvements.
- (b) Utility and Other Services; Drainage. Easements are reserved under, through and over the Condominium Property as may be required from time to time for utility, cable television, communications and monitoring systems, Life Safety Systems, digital or other satellite systems, broadband communications and other services and drainage in order to serve the Condominium and/or members of the Association. A Unit Owner shall do nothing within or outside his or her Unit that interferes with or impairs, or may interfere with or impair, the provision of such utility, cable television, communications, monitoring systems, Life Safety Systems, digital or other satellite systems, broadband communications or other service or drainage facilities or the use of these easements. The Association shall have an irrevocable right of access to each Unit to maintain, repair or replace the pipes, wires, ducts, vents, cables, conduits and other utility, cable television, communications, monitoring systems, Life Safety Systems, digital or other satellite systems, broadband communications, and drainage facilities, and Common Elements contained in the Unit or elsewhere in the Condominium Property, and to remove any Improvements interfering with or impairing such facilities or easements herein reserved; provided such right of access, except in the event of an emergency, shall not unreasonably interfere with the Unit Owner's permitted use of the Unit, and except in the event of an emergency, entry shall be made on not less than one (1) days' notice (which notice shall not, however, be required if the Unit Owner is absent when the giving of notice is attempted).
- (c) Encroachments. If (i) any portion of the Common Elements and/or the Association Property encroaches upon any Unit (or Limited Common Element appurtenant thereto); (ii) any Unit (or Limited Common Element appurtenant thereto) encroaches upon any other Unit or upon any portion of the Common Elements and/or Association Property (iii) any encroachment shall hereafter occur as a result of (A) settling or shifting of the Improvements; (B) any alteration or repair to the Common Elements made by or with the consent of the Association or Developer, as appropriate, or (C) any repair or restoration of the Improvements (or any portion thereof) or any Unit after damage by fire or other casualty or any taking by condemnation or eminent domain proceedings of all or any portion of any Unit or the Common Elements, then, in any such event, a valid easement shall exist for such encroachment and for the maintenance of same so long as the Improvements shall stand.
- (d) Ingress and Egress. A non-exclusive easement in favor of each Unit Owner and resident, their guests and invitees, and for each member of the Association shall exist for pedestrian traffic over, through and across sidewalks, streets, paths, walks, and other portions of the Common Elements and Association Property as from time to time may be intended and designated for such purpose and use by the Board; and for vehicular and pedestrian traffic over, through and across, and parking on, such portions of the Common Elements and Association Property as from time to time may be paved and intended for such purposes. None of the easements specified in this Subsection 3.4(d) shall be encumbered by any leasehold or lien other than those on the Condominium Parcels. Any such lien encumbering such easements (other than those on Condominium Parcels) automatically shall be subordinate to the rights of Unit Owners and the Association with respect to such easements.
- (e) Development; Maintenance. The Developer (including its affiliates and its or their designees, contractors, successors and assigns) shall have the right, in its (and their) sole discretion from time to time, to enter the Condominium Property and take all other action necessary or convenient for the purpose of undertaking and completing any renovations thereof, or any Improvements or Units located or to be located thereon, and/or any improvements located adjacent thereto and for repair, replacement and maintenance or



(Reserved for Clerk of Court)

warranty purposes or where the Developer, in its sole discretion, determines that it is required or desires to do so.

- (f) Sales Activity. Until such time as the Developer, (or any of its affiliates) is no longer offering units for sale in the ordinary course of business, the Developer, its designees, successors and assigns, shall have the right to use any Units and parts of the Common Elements or Association Property for guest accommodations, model apartments and sales, leasing and construction offices, to show model Units and the Common Elements and/ or any other portions of the Condominium to prospective purchasers and tenants of Units, and to erect on the Condominium Property and Association Property signs and other promotional material to advertise Units for sale or lease.
- (g) Warranty. For as long as Developer remains liable under any warranty, whether statutory, express or implied, for acts or omissions of Developer in the development, construction, sale, resale, leasing, financing and marketing of the Condominium, then Developer and its contractors, agents and designees shall have the right, in Developer's sole discretion and from time to time and without requiring prior approval of the Association and/or any Unit Owner and without requiring any consideration to be paid by the Developer to the Unit Owners and/or Condominium Association (provided, however, that absent an emergency situation, Developer shall provide reasonable advance notice), to enter the Condominium Property, including the Units, Common Elements and Limited Common Elements, for the purpose of inspecting, testing and surveying same to determine the need for repairs, improvements and/or replacements, and effecting same, so that Developer can fulfill any of its warranty obligations. The failure of the Association or any Unit Owner to grant, or to interfere with, such access, shall alleviate the Developer from having to fulfill its warranty obligations and the costs, expenses, liabilities or damages arising out of any unfulfilled Developer warranty will be the sole obligation and liability of the person or entity who or which impedes the Developer in any way in Developer's activities described in this Subsection 3.4(h). **Nothing herein shall be deemed or construed as the Developer making or offering any warranty, all of which are disclaimed (except to the extent same may not be) as set forth in Section 23 below.**
- (h) Exterior Building Maintenance. An easement is hereby reserved on, through and across each Unit and all Limited Common Elements appurtenant thereto in order to afford access to the Association (and its contractors) to perform roof repairs and/or replacements, repair, replace, maintain and/or alter rooftop mechanical equipment, to stage window washing equipment and to perform window washing and/or any other exterior maintenance and/or painting of the Building.
- (i) Additional Easements. The Association, through its Board, on the Association's behalf and on behalf of all Unit Owners (each of whom hereby appoints the Association as its attorney-in-fact for this purpose), shall have the right to grant such additional general ("blanket") and specific electric, gas or other utility, cable television, security systems, communications or service easements (and appropriate bills of sale for equipment, conduits, pipes, lines and similar installations pertaining thereto), or modify or relocate any such existing easements or drainage facilities, in any portion of the Condominium and/or Association Property, and to grant access easements or relocate any existing access easements in any portion of the Condominium and/or Association Property, as the Board shall deem necessary or desirable for the proper operation and maintenance of the Improvements, or for the general health or welfare of the Unit Owners and/or members of the Association, or for the purpose of carrying out any provisions of this Declaration, provided that such easements or the relocation of existing easements will not prevent or unreasonably interfere with the reasonable use of the Units for dwelling purposes.

4. Restraint Upon Separation and Partition of Common Elements. The undivided share in the Common Elements and Common Surplus which is appurtenant to a Unit, and the exclusive right to use all appropriate appurtenant Limited Common Elements which have not been transferred pursuant to this Declaration, shall not be separated therefrom and shall pass with the title to the Unit, whether or not separately described. The appurtenant share in the Common Elements and Common Surplus, and the exclusive right to use all Limited Common Elements appurtenant to a Unit, except as elsewhere herein provided to the contrary, cannot be conveyed or encumbered except together with the Unit. The respective shares in the Common Elements appurtenant to Units shall remain undivided, and no action for partition of the Common Elements, the Condominium Property, or any part thereof, shall lie, except as provided herein with respect to termination of the Condominium.

(Reserved for Clerk of Court)

5. Ownership of Common Elements and Common Surplus and Share of Common Expenses; Voting Rights

- 5.1 Percentage Ownership and Shares. The undivided percentage interest in the Common Elements and Common Surplus, and the percentage share of the Common Expenses, appurtenant to each Unit, is as set forth on **Exhibit "3"** attached hereto.
- 5.2 Voting. Each Unit shall be entitled to one (1) vote to be cast by its Owner in accordance with the provisions of the By-Laws and Articles of Incorporation of the Association. Each Unit Owner shall be a member of the Association.

6. Amendments. Except as elsewhere provided herein, amendments may be effected as follows:

- 6.1 By The Association. Notice of the subject matter of a proposed amendment shall be included in the notice of any meeting at which a proposed amendment is to be considered. A resolution for the adoption of a proposed amendment may be proposed either by a majority of the Board of Directors of the Association or by not less than one-third (1/3) of the Unit Owners. Except as elsewhere provided, approvals must be by an affirmative vote representing in excess of 66 2/3% or more of the voting interests of all Unit Owners. Directors and members not present in person or by proxy at the meeting considering the amendment may express their approval in writing, provided that such approval is delivered to the secretary at or prior to the meeting.
- 6.2 Material Amendments. Unless otherwise provided specifically to the contrary in this Declaration, no amendment shall change the configuration or size of any Unit in any material fashion, materially alter or modify the appurtenances to any Unit, or change the percentage by which the Owner of a Unit shares the Common Expenses and owns the Common Elements and Common Surplus (any such change or alteration being a "Material Amendment"), unless the record Owner(s) thereof, and all record owners of mortgages or other liens thereon, shall join in the execution of the amendment and the amendment is otherwise approved by in excess of 66 2/3% or more of the voting interests of Unit Owners. The acquisition of property by the Association, material alterations or substantial additions to such property or the Common Elements by the Association and installation, replacement, operation, repair and maintenance of approved hurricane shutters, if in accordance with the provisions of this Declaration, shall not be deemed to constitute a material alteration or modification of the appurtenances of the Units, and accordingly, shall not constitute a Material Amendment.
- 6.3 Mortgagee's Consent. No amendment may be adopted which would eliminate, modify, prejudice, abridge or otherwise adversely affect any rights, benefits, privileges or priorities granted or reserved to mortgagees of Units without the consent of said mortgagees in each instance; nor shall an amendment make any change in the sections hereof entitled "Insurance", "Reconstruction or Repair after Casualty", or "Condemnation" unless the Primary Institutional First Mortgagee shall join in the amendment. Except as specifically provided herein or if required by FNMA or FHLMC, the consent and/or joinder of any lien or mortgage holder on a Unit shall not be required for the adoption of an amendment to this Declaration and, whenever the consent or joinder of a lien or mortgage holder is required, such consent or joinder shall not be unreasonably withheld.
- 6.4 By The Developer. Notwithstanding anything herein contained to the contrary, during the time the Developer has the right to elect a majority of the Board of Directors of the Association, the Declaration, the Articles of Incorporation or the By-Laws of the Association may be amended by the Developer alone, without requiring the consent of any other party, to effect any change whatsoever, except for an amendment: (a) to permit time-share estates (which must be approved, if at all, by all Unit Owners and mortgagees on Units); or (b) to effect a Material Amendment which must be approved, if at all, in the manner set forth in Subsection 6.2 above. No amendment may be adopted which would eliminate, modify, prejudice, abridge or otherwise adversely affect any rights, benefits, privileges or priorities granted or reserved to the Developer, without the prior written consent of the Developer in each instance.
- 6.5 Execution and Recording. An amendment, other than amendments made by the Developer alone pursuant to the Act or this Declaration, shall be evidenced by a certificate of the Association, executed either by the President of the Association or a majority of the members of the Board of Directors which shall include recording data identifying the Declaration and shall be executed with the same formalities required for the execution of a deed. An amendment of the Declaration is effective when it is properly recorded in the public records of the County. No provision of this Declaration shall be revised or amended by reference to its title or number only. Proposals to amend existing provisions of this Declaration shall contain the full text of the provision to be amended; new words shall be inserted in the text underlined; and words to be deleted shall be

(Reserved for Clerk of Court)

lined through with hyphens. However, if the proposed change is so extensive that this procedure would hinder, rather than assist, the understanding of the proposed amendment, it is not necessary to use underlining and hyphens as indicators of words added or deleted, but, instead, a notation must be inserted immediately preceding the proposed amendment in substantially the following language: "Substantial rewording of Declaration. See provision. . . for present text." Nonmaterial errors or omissions in the amendment process shall not invalidate an otherwise properly adopted amendment.

7. Maintenance and Repairs.

7.1 Units and Limited Common Elements. All maintenance, repairs and replacements of, in or to any Unit and Limited Common Elements appurtenant thereto, whether structural or nonstructural, ordinary or extraordinary, foreseen or unforeseen, including, without limitation, maintenance, repair and replacement of windows, window coverings, interior nonstructural walls, the interior side of any entrance door and all other doors within or affording access to a Unit, and the electrical (including wiring), plumbing (including fixtures and connections), heating and air-conditioning equipment, fixtures and outlets, appliances, carpets and other floor coverings, all interior surfaces and the entire interior of the Unit lying within the boundaries of the Unit or the Limited Common Elements or other property belonging to the Unit Owner, shall be performed by the Owner of such Unit at the Unit Owner's sole cost and expense, except as otherwise expressly provided to the contrary herein.

7.2 Common Elements and Association Property. Except to the extent (a) expressly provided to the contrary herein, or (b) proceeds of insurance are made available therefor, all maintenance, repairs and replacements in or to the Common Elements (other than those Limited Common Elements or portions thereof to be maintained by the Unit Owners as provided above) and Association Property shall be performed by the Association and the cost and expense thereof shall be charged to all Unit Owners as a Common Expense, except to the extent arising from or necessitated by the negligence, misuse or neglect of specific Unit Owners, in which case such cost and expense shall be paid solely by such Unit Owners.

7.3 Specific Unit Owner Responsibility. The obligation to maintain and repair any air conditioning equipment, plumbing or electrical fixtures, screens (whether on windows or doors), screened enclosures and screen doors serving the Unit, or other items of property which service a particular Unit or Units shall be the responsibility of the applicable Unit Owners, individually, and not the Association, without regard to whether such items are included within the boundaries of the Units.

8. Additions, Improvements or Alterations by the Association. Whenever in the judgment of the Board of Directors, the Common Elements, the Association Property, or any part of either, shall require capital additions, alterations or improvements (as distinguished from repairs and replacements) costing in excess of three percent (3%) of the then applicable budget of the Association in the aggregate in any calendar year, the Association may proceed with such additions, alterations or improvements only if the making of such additions, alterations or improvements shall have been approved by a majority of the voting interests represented at a meeting at which a quorum is attained. Any such additions, alterations or improvements to such Common Elements, the Association Property, or any part of either, costing in the aggregate three percent (3%) or less of the then applicable budget of the Association in a calendar year may be made by the Association without approval of the Unit Owners. The cost and expense of any such additions, alterations or improvements to such Common Elements or Association Property shall constitute a part of the Common Expenses and shall be assessed to the Unit Owners as Common Expenses. For purposes of this Section, "aggregate in any calendar year" shall include the total debt incurred in that year, if such debt is incurred to perform the above-stated purposes, regardless of whether the repayment of any part of that debt is required to be made beyond that year.

9. Additions, Alterations or Improvements by Unit Owner.

9.1 Consent of the Board of Directors. No Unit Owner shall make any addition, alteration or improvement in or to the Common Elements, the Association Property, the Unit or any structural addition, alteration or improvement in or to his or her Unit or any Limited Common Element which is visible from any other Unit and/or the Common Elements without, in each instance, the prior written consent of the Board of Directors of the Association. Without limiting the generality of this Subsection 9.1, no Unit Owner shall cause or allow improvements or changes to his or her Unit, or to any Limited Common Elements, Common Elements or any property of the

(Reserved for Clerk of Court)

Condominium Association which does or could in any way affect, directly or indirectly, the structural, electrical, plumbing, Life Safety Systems, or mechanical systems, or any landscaping or drainage, of any portion of the Condominium Property, without first obtaining the written consent of the Board of the Association. No spas, hot tubs, whirlpools, infant portable pools or similar types of products will be permitted to be placed or installed on any lanai, terrace, balcony, or patio which is appurtenant to any Unit. The Board shall have the obligation to answer, in writing, any written request by a Unit Owner for approval of such an addition, alteration or improvement within thirty (30) days after such request and all additional information requested is received, and the failure to do so within the stipulated time shall constitute the Board's consent. The Board may condition the approval in any manner, including, without limitation, retaining approval rights of the contractor, or others, to perform the work and requiring the Unit Owner to obtain insurance naming the Developer and the Association as additional named insureds. The proposed additions, alterations and improvements by the Unit Owners shall be made in compliance with all laws, rules, ordinances and regulations of all governmental authorities having jurisdiction, and with any conditions imposed by the Association with respect to design, structural integrity, aesthetic appeal, construction details, lien protection or otherwise. Once approved by the Board of Directors, such approval may not be revoked.

A Unit Owner making or causing to be made any such additions, alterations or improvements agrees, and shall be deemed to have agreed, for such Owner, and his heirs, personal representatives, successors and assigns, as appropriate, to hold the Association, the Developer and all other Unit Owners harmless from and to indemnify them for any liability or damage to the Condominium and/or Association Property and expenses arising therefrom, and shall be solely responsible for the maintenance, repair and insurance thereof from and after that date of installation or construction thereof as may be required by the Association. The Association's rights of review and approval of plans and other submissions under this Declaration are intended solely for the benefit of the Association. Neither the Developer, the Association nor any of its officers, directors, employees, agents, contractors, consultants or attorneys shall be liable to any Owner or any other person by reason of mistake in judgment, failure to point out or correct deficiencies in any plans or other submissions, negligence, or any other misfeasance, malfeasance or nonfeasance arising out of or in connection with the approval or disapproval of any plans or submissions.

Anyone submitting plans hereunder, by the submission of same, and any Owner, by acquiring title to same, agrees not to seek damages from the Developer and/or the Association arising out of the Association's review of any plans hereunder. Without limiting the generality of the foregoing, the Association shall not be responsible for reviewing, nor shall its review of any plans be deemed approval of, any plans from the standpoint of structural safety, soundness, workmanship, materials, usefulness, conformity with building or other codes or industry standards, or compliance with governmental requirements. Further, each Owner (including the successors and assigns) agrees to indemnify and hold the Developer and the Association harmless from and against any and all costs, claims (whether rightfully or wrongfully asserted), damages, expenses or liabilities whatsoever (including, without limitation, reasonable attorneys' fees and court costs at all trial and appellate levels), arising out of any review of plans by the Association hereunder.

9.2 Life Safety Systems. No Unit Owner shall make any additions, alterations or improvements to the Life Safety Systems and/or to any other portion of the Condominium Property which may alter or impair the Life Safety Systems or access to the Life Safety Systems, without first receiving the prior written approval of the Board. In that regard, no lock, chain or other device or combination thereof shall be installed or maintained at any time on or in connection with any door on which panic hardware or fire exit hardware is required. Stairwell identification and emergency signage shall not be altered or removed whatsoever by any Unit Owner. No barrier including, but not limited to personalty, shall impede the free movement of ingress and egress to and from all emergency ingress and egress passageways.

9.3 Improvements, Additions or Alterations by Developer. Anything to the contrary notwithstanding, the foregoing restrictions of this Section 9 shall not apply to Developer-owned Units and/or improvements made thereto. The Developer shall have the additional right, without the consent or approval of the Board of Directors or other Unit Owners, to (a) make alterations, additions or improvements, structural and non-structural, interior and exterior, ordinary and extraordinary, in, to and upon any Unit owned by it and Limited Common Elements appurtenant thereto (including, without limitation, the removal of walls, floors, ceilings and other structural portions of the Improvements), and (b) expand, alter or add to all or any part of the recreational facilities. Any amendment to this Declaration required by a change made by the Developer pursuant to this Section 9.3 shall be adopted in accordance with Section 6 and Section 6.2 of this Declaration.

(Reserved for Clerk of Court)

10. Changes in Developer-Owned Units. Without limiting the generality of the provisions of Subsection 9.3 above, and anything to the contrary notwithstanding, the Developer shall have the right, without the vote or consent of the Association or Unit Owners, to (a) make alterations, additions or improvements in, to and upon Units owned by the Developer, whether structural or non-structural, interior or exterior, ordinary or extraordinary; (b) change the layout or number of rooms in any Developer owned Units; (c) change the size of Developer owned Units by combining separate Developer owned Units into a single apartment (although being kept as two separate legal Units), or otherwise; and (d) reapportion among the Developer owned Units affected by such change in size pursuant to the preceding clause, their appurtenant interests in the Common Elements and share of the Common Surplus and Common Expenses; provided, however, that the percentage interest in the Common Elements and share of the Common Surplus and Common Expenses of any Units (other than the affected Developer-owned Units) shall not be changed by reason thereof unless the Owners of such Units shall consent thereto and, provided further, that Developer shall comply with all laws, ordinances and regulations of all governmental authorities having jurisdiction in so doing. In making the above alterations, additions and improvements, the Developer may relocate and alter Common Elements adjacent to or near such Units, incorporate portions of the Common Elements into adjacent Units and incorporate Units, or portions thereof, into adjacent Common Elements, provided that such relocation and alteration does not materially adversely affect the market value or ordinary use of Units owned by Unit Owners other than the Developer. Any amendments to this Declaration required by changes of the Developer made pursuant to this Section 10, shall be effected by the Developer alone pursuant to Subsection 6.4, without the vote or consent of the Association or Unit Owners (or their mortgagees) required, except to the extent that any of same constitutes a Material Amendment, in which event, the amendment must be approved as set forth in Subsection 6.2 above. Without limiting the generality of Subsection 6.4 hereof, the provisions of this Section may not be added to, amended or deleted without the prior written consent of the Developer.
11. Operation of the Condominium by the Association; Powers and Duties.
- 11.1 Powers and Duties. The Association shall be the entity responsible for the operation of the Condominium and the Association Property. The powers and duties of the Association shall include those set forth in the By-Laws and Articles of Incorporation of the Association (respectively, **Exhibits "4" and "5"** annexed hereto), as amended from time to time. The affairs of the Association shall be governed by a Board of not less than three (3) nor more than nine (9) directors. Directors (other than designees of the Developer) must be Unit Owners (or, if a Unit is owned by a business entity, then the director(s) may be an officer, director, shareholder, manager, or member of such business entity, as applicable) and be natural persons who are 18 years of age or older. Any person who has been convicted of any felony by any court of record in the United States and who has not had his or her right to vote restored pursuant to law in the jurisdiction of his or her residence is not eligible for Board membership (provided, however, that the validity of any Board action is not affected if it is later determined that a member of the Board is ineligible for Board membership due to having been convicted of a felony). In addition, the Association shall have all the powers and duties set forth in the Act, as well as all powers and duties granted to or imposed upon it by this Declaration, including, without limitation:
- (a) The irrevocable right to have access to each Unit and Limited Common Elements appurtenant thereto from time to time during reasonable hours as may be necessary for pest control, or other purposes and for the maintenance, repair or replacement of any Common Elements or any portion of a Unit, if any, to be maintained by the Association, or at any time and by force, if necessary, to prevent damage to the Common Elements, the Association Property or to a Unit or Units, including, without limitation, (but without obligation or duty) to install and/or close hurricane shutters in the event of the issuance of a storm watch or storm warning and/or to maintain, repair, replace and/or operate Life Safety Systems
  - (b) The power to make and collect Assessments and other charges against Unit Owners and to lease, maintain, repair and replace the Common Elements and Association Property.
  - (c) The duty to maintain accounting records according to good accounting practices, which shall be open to inspection by Unit Owners or their authorized representatives at reasonable times upon prior written request.
  - (d) The power to contract for the management and maintenance of the Condominium Property and to authorize a management agent (who may be an affiliate of the Developer) to assist the Association in carrying out its powers and duties by performing such functions as reviewing and evaluating the submission of proposals, collection of Assessments, preparation of records, enforcement of rules and maintenance, repair and

(Reserved for Clerk of Court)

replacement of Common Elements with such funds as shall be made available by the Association for such purposes. The Association and its officers shall, however, retain at all times the powers and duties granted in the Condominium documents and the Condominium Act, including, but not limited to, the making of Assessments, promulgation of rules and execution of contracts on behalf of the Association.

- (e) The power to borrow money, execute promissory notes and other evidences of indebtedness and to give as security therefor mortgages and security interests in property owned by the Association, if any, provided that such actions are approved by a majority of the entire membership of the Board of Directors and a majority of the Units represented at a meeting at which a quorum has been attained, or by such greater percentage of the Board or Unit Owners as may be specified in the By-Laws with respect to certain borrowing. The foregoing restriction shall not apply if such indebtedness is entered into for the purpose of financing insurance premiums, which action may be undertaken solely by the Board of Directors, without requiring a vote of the Unit Owners.
- (f) The power to adopt and amend rules and regulations concerning the details of the operation and use of the Condominium and Association Property.
- (g) The power to acquire, convey, lease and encumber real and personal property. Personal property shall be acquired, conveyed, leased or encumbered upon a majority vote of the Board of Directors, subject to Section 8 hereof. Real property (including, without limitation, any of the Units) shall be acquired, conveyed, leased or encumbered upon a majority vote of the Board of Directors alone; provided that the requirements of Section 8 pertaining to the Unit Owners' approval of costs in excess of the threshold amount stated therein (including the proviso regarding the debt incurred) shall also apply to the acquisition of real property; provided, further, however, that the acquisition of any Unit as a result of a foreclosure of the lien for Assessments (or by deed in lieu of foreclosure) shall be made upon the majority vote of the Board, regardless of the price for same and the Association, through its Board, has the power to hold, lease, mortgage or convey the acquired Unit(s) without requiring the consent of Unit Owners. The expenses of ownership (including the expense of making and carrying any mortgage related to such ownership), rental, membership fees, taxes, Assessments, operation, replacements and other expenses and undertakings in connection therewith shall be Common Expenses.
- (h) The power to execute all documents or consents, on behalf of all Unit Owners (and their mortgagees), required by all governmental and/or quasi-governmental agencies in connection with land use and development matters (including, without limitation, plats, waivers of plat, unities of title, covenants in lieu thereof, etc.), and in that regard, each Owner, by acceptance of the deed to such Owner's Unit, and each mortgagee of a Unit Owner by acceptance of a lien on said Unit, appoints and designates the President of the Association, as such Owner's agent and attorney-in-fact to execute any and all such documents or consents.
- (i) All of the powers which a corporation not for profit in the State of Florida may exercise pursuant to this Declaration, the Articles of Incorporation, the Bylaws, Chapters 607 and 617, Florida Statutes and the Act, in all cases except as expressly limited or restricted in the Act.

In the event of conflict among the powers and duties of the Association, this Declaration shall take precedence over the Articles of Incorporation, By-Laws and applicable rules and regulations; the Articles of Incorporation shall take precedence over the By-Laws and applicable rules and regulations; and the By-Laws shall take precedence over applicable rules and regulations, all as amended from time to time. Notwithstanding anything in this Declaration or its exhibits to the contrary, the Association shall at all times be the entity having ultimate control over the Condominium, consistent with the Act.

- 11.2 Limitation Upon Liability of Association. Notwithstanding the duty of the Association to maintain and repair parts of the Condominium Property, the Association shall not be liable to Unit Owners for injury or damage, other than for the cost of maintenance and repair, caused by any latent condition of the Condominium Property. Further, the Association shall not be liable for any such injury or damage caused by defects in design or workmanship or any other reason connected with any additions, alterations or improvements or other activities done by or on behalf of any Unit Owners regardless of whether or not same shall have been approved by the Association pursuant to Section hereof. The Association also shall not be liable to any Unit Owner or lessee

(Reserved for Clerk of Court)

or to any other person or entity for any property damage, personal injury, death or other liability on the grounds that the Association did not obtain or maintain insurance (or carried insurance with any particular deductible amount) for any particular matter where: (i) such insurance is not required hereby; or (ii) the Association could not obtain such insurance at reasonable costs or upon reasonable terms.

- 11.3 Restraint Upon Assignment of Shares in Assets. The share of a Unit Owner in the funds and assets of the Association cannot be assigned, hypothecated or transferred in any manner except as an appurtenance to his Unit.
- 11.4 Approval or Disapproval of Matters. Whenever the decision of a Unit Owner is required upon any matter, whether or not the subject of an Association meeting, that decision shall be expressed by the same person who would cast the vote for that Unit if at an Association meeting, unless the joinder of all record Owners of the Unit is specifically required by this Declaration or by law.
- 11.5 Acts of the Association. Unless the approval or action of Unit Owners, and/or a certain specific percentage of the Board of Directors of the Association, is specifically required in this Declaration, the Articles of Incorporation or By-Laws of the Association, applicable rules and regulations or applicable law, all approvals or actions required or permitted to be given or taken by the Association shall be given or taken by the Board of Directors, without the consent of Unit Owners, and the Board may so approve and act through the proper officers of the Association without a specific resolution. When an approval or action of the Association is permitted to be given or taken hereunder or thereunder, such action or approval may be conditioned in any manner the Association deems appropriate or the Association may refuse to take or give such action or approval without the necessity of establishing the reasonableness of such conditions or refusal.
- 11.6 Effect on Developer So long as Developer holds a Unit for sale in the ordinary course of business, none of the following actions may be taken by the Association (subsequent to control thereof being assumed by Unit Owners other than the Developer without the prior written approval of the Developer:
- (a) Assessment of the Developer as a Unit Owner for capital improvements;
  - (b) Any action by the Association that would be detrimental to the sales of Units by the Developer) or the assignment of Limited Common Elements by the Developer for consideration; provided, however, that an increase in Assessments for Common Expenses without discrimination against the Developer shall not be deemed to be detrimental to the sales of Units.
12. Determination of Common Expenses and Fixing of Assessments Therefor. The Board of Directors shall from time to time, and at least annually, prepare a budget for the Condominium and the Association, determine the amount of Assessments payable by the Unit Owners to meet the Common Expenses of the Condominium and allocate and assess such expenses among the Unit Owners in accordance with the provisions of this Declaration and the By-Laws. The Board of Directors shall advise all Unit Owners promptly in writing of the amount of the Assessments payable by each of them as determined by the Board of Directors as aforesaid and shall furnish copies of the budget, on which such Assessments are based, to all Unit Owners and (if requested in writing) to their respective mortgagees. The Common Expenses shall include the expenses of and reserves for (if required by, and not waived in accordance with, applicable law) the operation, maintenance, repair and replacement of the Common Elements and Association Property, costs of carrying out the powers and duties of the Association and any other expenses designated as Common Expenses by the Act, this Declaration, the Articles or By-Laws of the Association, applicable rules and regulations or by the Association. Incidental income to the Association, if any, may be used to pay regular or extraordinary Association expenses and liabilities, to fund reserve accounts, or otherwise as the Board shall determine from time to time, and need not be restricted or accumulated. Any Budget adopted shall be subject to change to cover actual expenses at any time. Any such change shall be adopted consistent with the provisions of this Declaration and the By-Laws.

(Reserved for Clerk of Court)

13. Collection of Assessments.

- 13.1 Liability for Assessments. A Unit Owner, regardless of how title is acquired, including by purchase at a foreclosure sale or by deed in lieu of foreclosure shall be liable for all Assessments coming due while he is the Unit Owner. Additionally, a Unit Owner shall be jointly and severally liable with the previous Owner for all unpaid Assessments that came due up to the time of the conveyance, without prejudice to any right the Owner may have to recover from the previous Owner the amounts paid by the grantee Owner. The liability for Assessments may not be avoided by waiver of the use or enjoyment of any Common Elements or by the abandonment of the Unit for which the Assessments are made or otherwise.
- 13.2 Special and Capital Improvement Assessments. In addition to Assessments levied by the Association to meet the Common Expenses of the Condominium and the Association, the Board of Directors may levy "Special Assessments" and "Capital Improvement Assessments" upon the following terms and conditions:
- (a) "Special Assessments" shall mean and refer to a charge against each Owner and his Unit, representing a portion of the costs incurred by the Association for specific purposes of a nonrecurring nature which are not in the nature of capital improvements.
  - (b) "Capital Improvement Assessments" shall mean and refer to a charge against each Owner and his Unit, representing a portion of the costs incurred by the Association for the acquisition, installation, construction or replacement (as distinguished from repairs and maintenance) of any capital improvements located or to be located within the Common Elements or Association Property.
  - (c) Special Assessments and Capital Improvement Assessments may be levied by the Board and shall be payable in lump sums or installments, in the discretion of the Board; provided that, if such Special Assessments or Capital Improvement Assessments, in the aggregate in any year, exceed three percent (3%) of the then estimated operating budget of the Association, the Board must obtain approval of a majority of the Voting Interests represented at a meeting at which a quorum is attained.
- 13.3 Default in Payment of Assessments for Common Expenses. Assessments and installments thereof not paid within ten (10) days from the date when they are due shall bear interest at fifteen percent (15%) per annum from the date due until paid and shall be subject to an administrative late fee in an amount not to exceed the greater of \$25.00 or five percent (5%) of each delinquent installment. The Association has a lien on each Condominium Parcel to secure the payment of Assessments. Except as set forth below, the lien is effective from, and shall relate back to, the date of the recording of this Declaration. However, as to a first mortgage of record, the lien is effective from and after the date of the recording of a claim of lien in the Public Records of the County, stating the description of the Condominium Parcel, the name of the record Owner and the name and address of the Association. The lien shall be evidenced by the recording of a claim of lien in the Public Records of the County. To be valid, the claim of lien must state the description of the Condominium Parcel, the name of the record Owner, the name and address of the Association, the amount due and the due dates, and the claim of lien must be executed and acknowledged by an officer or authorized officer of the Association. The claim of lien shall not be released until all sums secured by it (or such other amount as to which the Association shall agree by way of settlement) have been fully paid or until it is barred by law. No such lien shall be effective longer than one (1) year after the claim of lien has been recorded unless, within that one (1) year period, an action to enforce the lien is commenced. The one (1) year period shall automatically be extended for any length of time during which the Association is prevented from filing a foreclosure action by an automatic stay resulting from a bankruptcy petition filed by the Owner or any other person claiming an interest in the Unit. The claim of lien shall secure (whether or not stated therein) all unpaid Assessments, which are due and which may accrue subsequent to the recording of the claim of lien and prior to the entry of a certificate of title, as well as interest and all reasonable costs and attorneys' fees incurred by the Association incident to the collection process. Upon payment in full, the person making the payment is entitled to a satisfaction of the lien in recordable form. The Association may bring an action in its name to foreclose a lien for unpaid Assessments in the manner a mortgage of real property is foreclosed and may also bring an action at law to recover a money judgment for the unpaid Assessments without waiving any claim of lien. The Association is entitled to recover its reasonable attorneys' fees incurred either in a lien foreclosure action or an action to recover a money judgment for unpaid Assessments.



(Reserved for Clerk of Court)

As an additional right and remedy of the Association, upon default in the payment of Assessments as aforesaid and after thirty (30) days' prior written notice to the applicable Unit Owner and the recording of a claim of lien, the Association may accelerate and declare immediately due and payable all installments of Assessments for the remainder of the fiscal year. In the event that the amount of such installments changes during the remainder of the fiscal year, the Unit Owner or the Association, as appropriate, shall be obligated to pay or reimburse to the other the amount of increase or decrease within ten (10) days of same taking effect.

- 13.4 Notice of Intention to Foreclose Lien. No foreclosure judgment may be entered until at least thirty (30) days after the Association gives written notice to the Unit Owner of its intention to foreclose its lien to collect the unpaid Assessments. If this notice is not given at least thirty (30) days before the foreclosure action is filed, and if the unpaid Assessments, including those coming due after the claim of lien is recorded, are paid before the entry of a final judgment of foreclosure, the Association shall not recover attorney's fees or costs. The notice must be given by delivery of a copy of it to the Unit Owner or by certified or registered mail, return receipt requested, addressed to the Unit Owner at the last known address, and upon such mailing, the notice shall be deemed to have been given. If after diligent search and inquiry the Association cannot find the Unit Owner or a mailing address at which the Unit Owner will receive the notice, the court may proceed with the foreclosure action and may award attorney's fees and costs as permitted by law. The notice requirements of this Section are satisfied if the Unit Owner records a Notice of Contest of Lien as provided in the Act.
- 13.5 Appointment of Receiver to Collect Rental. If the Unit Owner remains in possession of the Unit after a foreclosure judgment has been entered, the court in its discretion may require the Unit Owner to pay a reasonable rental for the Unit. If the Unit is rented or leased during the pendency of the foreclosure action, the Association is entitled to the appointment of a receiver to collect the rent. The expenses of such receiver shall be paid by the party which does not prevail in the foreclosure action.
- 13.6 First Mortgagee. The liability of the holder of a first mortgage on a Unit (each, a "First Mortgagee"), or its successors or assigns, who acquires title to a Unit by foreclosure or by deed in lieu of foreclosure for the unpaid Assessments (or installments thereof) that became due prior to the First Mortgagee's acquisition of title is limited to the lesser of:
- (a) The Unit's unpaid Common Expenses and regular periodic Assessments which accrued or came due during the six (6) months immediately preceding the acquisition of title and for which payment in full has not been received by the Association; or
  - (b) One percent (1%) of the original mortgage debt.

As to a Unit acquired by foreclosure, the limitations set forth in clauses (a) and (b) above shall not apply unless the First Mortgagee joined the Association as a defendant in the foreclosure action. Joinder of the Association, however, is not required if, on the date the complaint is filed, the Association was dissolved or did not maintain an office or agent for service of process at a location which was known to or reasonably discoverable by the mortgagee.

A First Mortgagee acquiring title to a Unit as a result of foreclosure or deed in lieu thereof may not, during the period of its ownership of such Unit, whether or not such Unit is unoccupied, be excused from the payment of any of the Common Expenses coming due during the period of such ownership.

- 13.7 Developer's Liability for Assessments. During the period from the date of the recording of this Declaration until the earlier of the following dates (the "Guarantee Expiration Date"): (a) the last day of the twelfth (12<sup>th</sup>) full calendar month following the recording of this Declaration, or (b) the date that control of the Association is transferred to Unit Owners other than the Developer as provided in the By-Laws and the Act, the Developer shall not be obligated to pay the share of Common Expenses and Assessments attributable to the Units owned thereby, provided: (i) that the regular Assessments for Common Expenses imposed on each Unit Owner other than the Developer prior to the Guarantee Expiration Date shall not increase during such period over the amounts set forth on **Exhibit "6"** attached hereto; and (ii) that the Developer shall be obligated to pay any amount of Common Expenses actually incurred during such period and not produced by the Assessments at the guaranteed levels receivable from other Unit Owners. After the Guarantee Expiration Date, the Developer shall have the option, in its sole discretion, of extending the guarantee for eight (8) additional six (6) month periods, or paying the share of Common Expenses and Assessments attributable to Units it then owns.

(Reserved for Clerk of Court)

Notwithstanding the above and as provided in Section 718.116(9)(a)(2) of the Act, in the event of an Extraordinary Financial Event (as hereinafter defined), the costs necessary to effect restoration shall be assessed against all Unit Owners owning units on the date of such Extraordinary Financial Event, and their successors and assigns, including the Developer. As used in this Subsection, an "Extraordinary Financial Event" shall mean Common Expenses incurred prior to the Guarantee Expiration Date (as same may be extended) resulting from a natural disaster or Act of God, which is not covered by insurance proceeds from the insurance maintained by the Association as required by Section 718.111(11)(a) of the Act.

- 13.8 Estoppel Statement. Within fifteen (15) days after receiving a written request therefor from a purchaser, Unit Owner or mortgagee of a Unit, the Association shall provide a certificate, signed by an officer or agent of the Association, stating all Assessments and other moneys owed to the Association by the Unit Owner with respect to his Unit. Any person other than the Unit Owner who relies upon such certificate shall be protected thereby. The Association or its authorized agent may charge a reasonable fee for the preparation of such certificate.
- 13.9 Installments. Regular Assessments shall be collected monthly or quarterly, in advance, at the option of the Association. Initially, assessments will be collected monthly, and be due on the first day of each calendar month.
- 13.10 Application of Payments. Any payments received by the Association from a delinquent Unit Owner shall be applied first to any interest accrued on the delinquent installment(s) as aforesaid, then to any administrative late fees, then to any costs and reasonable attorneys' fees incurred in collection and then to the delinquent and any accelerated Assessments. The foregoing shall be applicable notwithstanding any restrictive endorsement, designation or instruction placed on or accompanying a payment.
14. Insurance. Insurance covering the Condominium Property and the Association Property shall be governed by the following provisions:
- 14.1 Purchase, Custody and Payment.
- (a) Purchase. All insurance policies described herein covering portions of the Condominium and Association Property shall be purchased by the Association and shall be issued by an insurance company authorized to do business in Florida, or by a surplus lines carrier reasonably acceptable to the Board.
  - (b) Approval. Each insurance policy, the agency and company issuing the policy and the Insurance Trustee (if appointed) hereinafter described shall be subject to the approval of the Primary Institutional First Mortgagee in the first instance, if requested thereby.
  - (c) Named Insured. The named insured shall be the Association, individually, and as agent for Owners of Units covered by the policy, without naming them, and as agent for their mortgagees, without naming them. The Unit Owners and their mortgagees shall be deemed additional named insureds.
  - (d) Custody of Policies and Payment of Proceeds. All policies shall provide that payments for losses made by the insurer shall be paid to the Association or to the Insurance Trustee (if appointed), and all policies and endorsements thereto shall be deposited with the Association or to the Insurance Trustee (if appointed).
  - (e) Copies to Mortgagees. One copy of each insurance policy, or a certificate evidencing such policy, and all endorsements thereto, shall be furnished by the Association upon request to each Institutional First Mortgagee who holds a mortgage upon a Unit covered by the policy. Copies or certificates shall be furnished not less than ten (10) days prior to the beginning of the term of the policy, or not less than ten (10) days prior to the expiration of each preceding policy that is being renewed or replaced, as appropriate.
  - (f) Personal Property and Liability. Except as specifically provided herein or by the Act, the Association shall not be responsible to Unit Owners to obtain insurance coverage upon the property lying within the boundaries of their Unit, including, but not limited to, their personal property, and for their personal liability, moving and relocation expenses, lost rent expenses and living expenses and for any other risks not otherwise insured in

(Reserved for Clerk of Court)

accordance herewith. To the extent that a Unit Owner or other occupant of a Unit desires coverage for such excluded items, it shall be the sole responsibility of the Unit Owner and/or occupant to obtain.

14.2 Coverage. The Association shall maintain insurance covering the following:

- (a) Casualty. The Insured Property (as hereinafter defined) shall be insured in an amount not less than 100% of the full insurable replacement value thereof, excluding foundation and excavation costs (and subject to such reasonable deductibles as discussed below). The policy shall provide primary coverage for the following (the "Insured Property"): (i) all portions of the Condominium Property located outside the Units, (ii) the Condominium Property located inside the Units as such property was initially installed, or replacements thereof of like kind and quality and in accordance with the original plans and specifications or, if the original plans and specifications are not available, as they existed at the time that the Unit was initially conveyed, and (iii) the Building (including all fixtures, installations or additions comprising that part of the Building within the boundaries of the Units and required by the Act to be insured under the Association's policies) and all Improvements located on the Common Elements and the Association Property from time to time, together with all fixtures, building service equipment, personal property and supplies constituting the Common Elements or Association Property. Notwithstanding the foregoing, the Insured Property shall not include, and shall specifically exclude, all floor, wall and ceiling coverings, electrical fixtures, appliances, air conditioner and/or heating equipment, water heaters, water filters, built-in cabinets and countertops, and window treatments, including curtains, drapes, blinds, hardware and similar window treatment components, or replacements of any of the foregoing which are located within the boundaries of a Unit and serve only one Unit and all air conditioning compressors that service only an individual Unit, if any, whether or not located within the Unit boundaries. Such policies may contain reasonable deductible provisions as determined by the Board of Directors of the Association. Such coverage shall afford protection against loss or damage by fire and other hazards covered by a standard extended coverage endorsement, and such other risks as from time to time are customarily covered with respect to buildings and improvements similar to the Insured Property in construction, location and use, including, but not limited to, vandalism and malicious mischief.
- (b) Liability. Comprehensive general public liability and automobile liability insurance covering loss or damage resulting from accidents or occurrences on or about or in connection with the Insured Property or adjoining driveways and walkways, subject to this Declaration, or any work, matters or things related to the Insured Property, with such coverage as shall be required by the Board of Directors of the Association, but with combined single limit liability of not less than \$1,000,000 for each accident or occurrence, \$100,000 per person and \$50,000 property damage, and with a cross liability endorsement to cover liabilities of the Unit Owners as a group to any Unit Owner, and vice versa. The Association may also obtain and maintain liability insurance for its directors and officers and for the benefit of the Association's employees, in such amounts and under such terms and conditions as the Association deems appropriate in its sole and absolute discretion.
- (c) Worker's Compensation and other mandatory insurance, when applicable.
- (d) Flood Insurance covering the Common Elements, Association Property and Units if required by the Primary Institutional First Mortgagee or FNMA/FHLMC, or if the Association so elects.
- (e) Fidelity Insurance or Fidelity Bonds. The Association shall obtain and maintain adequate insurance or fidelity bonding of all persons who control or disburse Association funds which shall include, without limitation, those individuals authorized to sign Association checks and the president, secretary and treasurer of the Association. The insurance policy or fidelity bond shall be in such amount as shall be determined by a majority of the Board, but must be sufficient to cover the maximum funds that will be in the custody of the Association or its management agent at any one time. The premiums on such bonds and/or insurance shall be paid by the Association as a Common Expense.

(Reserved for Clerk of Court)

- (f) Association Property. Appropriate additional policy provisions, policies or endorsements extending the applicable portions of the coverage described above to all Association Property, where such coverage is available.
- (g) Such Other Insurance as the Board of Directors of the Association shall determine from time to time to be desirable.

When appropriate and obtainable, each of the foregoing policies shall waive the insurer's right to: (i) subrogation against the Association and against the Unit Owners individually and as a group, (ii) pay only a fraction of any loss in the event of coinsurance or if other insurance carriers have issued coverage upon the same risk, and (iii) avoid liability for a loss that is caused by an act of the Board of Directors of the Association, a member of the Board of Directors of the Association, one or more Unit Owners or as a result of contractual undertakings. Additionally, each policy shall provide that any insurance trust agreement will be recognized, that the insurance provided shall not be prejudiced by any act or omissions of individual Unit Owners that are not under the control of the Association, and that the policy shall be primary, even if a Unit Owner has other insurance that covers the same loss.

Every casualty insurance policy obtained by the Association, if required by FNMA/FHLMC, and if generally available, shall have the following endorsements: (i) agreed amount and inflation guard and (ii) steam boiler coverage (providing at least \$50,000 coverage for each accident at each location), if applicable.

- 14.3 Additional Provisions. All policies of insurance shall provide that such policies may not be canceled or substantially modified without at least thirty (30) days' prior written notice to all of the named insureds, including all mortgagees of Units. Prior to obtaining any policy of casualty insurance or any renewal thereof, the Board of Directors may (or if required by FNMA/FHLMC, shall) obtain an appraisal from a fire insurance company, or other competent insurance appraiser, of the full insurable replacement value of the Insured Property (exclusive of foundations), without deduction for depreciation, for the purpose of determining the amount of insurance to be effected pursuant to this Section 14.
- 14.4 Premiums. Premiums upon insurance policies purchased by the Association shall be paid by the Association as a Common Expense, except that the costs of fidelity bonding for any management company employee may be paid by such company pursuant to its contract with the Association. Premiums may be financed in such a manner as the Board of Directors deems appropriate. The Board shall determine the appropriate deductible for each policy of insurance. Each Owner, by acceptance of a deed or other conveyance of a Unit, hereby ratifies and confirms any decisions made by the Association in this regard and recognizes and agrees that funds to cover the deductible must be provided from the general operating funds of the Association before the Association will be entitled to insurance proceeds. The Association may, but shall not be obligated to, establish a reserve to cover any applicable deductible.
- 14.5 Insurance Trustee or Association; Share of Proceeds. If an Insurance Trustee has not been appointed by the Association, then the Association is hereby irrevocably appointed as an agent and attorney-in-fact for each and every Unit Owner, for each Institutional First Mortgagee and/or each owner of any other interest in the Condominium Property to adjust and settle any and all claims arising under any insurance policy purchased by the Association and to execute and deliver releases upon the payment of claims, if any. The decision to engage or appoint an Insurance Trustee, or not to do so, lies solely with the Association. All insurance policies obtained by or on behalf of the Association shall be for the benefit of the Association, the Unit Owners and their mortgagees, as their respective interests may appear, and shall provide that all proceeds covering property losses shall be paid to the Association or to the Insurance Trustee, if one is appointed by the Association, which may be designated by the Board of Directors as provided in Subsection 14.10 below and in this Subsection 14.5, and which, if so appointed, shall be a bank or trust company in Florida with trust powers, with its principal place of business in the State of Florida. The Insurance Trustee shall not be liable for payment of premiums, or for the renewal or the sufficiency of policies, nor for the failure to collect any insurance proceeds. The duty of the Insurance Trustee or the Association, as applicable, shall be to receive such proceeds as are paid and to hold the same in trust for the purposes elsewhere stated herein, and for the benefit of the Unit Owners and their respective mortgagees in the following shares, but shares need not be set forth on the records of the Insurance Trustee:
  - (a) Insured Property. Proceeds on account of damage to the Insured Property shall be held in undivided shares for each Unit Owner, such shares being the same as the undivided

(Reserved for Clerk of Court)

shares in the Common Elements appurtenant to each Unit, provided that if the Insured Property so damaged includes property lying within the boundaries of specific Units, that portion of the proceeds allocable to such property shall be held as if that portion of the Insured Property were Optional Property as described in paragraph (b) below.

- (b) Optional Property. Proceeds on account of damage solely to Units and/or certain portions or all of the contents thereof not included in the Insured Property (all as determined by the Association in its sole discretion) (collectively the "Optional Property"), if any is collected by reason of optional insurance which the Association elects to carry thereon (as contemplated herein), shall be held for the benefit of Owners of Units or other portions of the Optional Property damaged in proportion to the cost of repairing the damage suffered by each such affected Owner, which cost and allocation shall be determined in the sole discretion of the Association.
  - (c) Mortgagees. No mortgagee shall have any right to determine or participate in the determination as to whether or not any damaged property shall be reconstructed or repaired, and no mortgagee shall have any right to apply or have applied to the reduction of a mortgage debt any insurance proceeds, except for actual distributions thereof made to the Unit Owner and mortgagee pursuant to the provisions of this Declaration.
- 14.6 Distribution of Proceeds. Proceeds of insurance policies received by the Association and/or Insurance Trustee, as applicable, shall be distributed to or for the benefit of the beneficial owners thereof in the following manner:
- (a) Expenses of the Trustee. All expenses of the Insurance Trustee (if any) shall be first paid or provision shall be made therefor.
  - (b) Reconstruction or Repair. If the damaged property for which the proceeds are paid is to be repaired or reconstructed, the remaining proceeds shall be paid to defray the cost thereof as elsewhere provided herein. Any proceeds remaining after defraying such costs shall be distributed to the beneficial owners thereof, remittances to Unit Owners and their mortgagees being payable jointly to them.
  - (c) Failure to Reconstruct or Repair. If it is determined in the manner elsewhere provided that the damaged property for which the proceeds are paid shall not be reconstructed or repaired, the remaining proceeds shall be allocated among the beneficial owners as provided in Subsection 14.5 above, and distributed first to all Institutional First Mortgagees in an amount sufficient to pay off their mortgages, and the balance, if any, to the beneficial owners.
  - (d) Certificate. In making distributions to Unit Owners and their mortgagees, the Insurance Trustee (if appointed) may rely upon a certificate of the Association made by its President and Secretary as to the names of the Unit Owners and their mortgagees and their respective shares of the distribution.
- 14.7 Association as Agent. The Association is hereby irrevocably appointed as agent and attorney-in-fact for each Unit Owner and for each owner of a mortgage or other lien upon a Unit and for each owner of any other interest in the Condominium Property to adjust all claims arising under insurance policies purchased by the Association and to execute and deliver releases upon the payment of claims.
- 14.8 Unit Owners' Personal Coverage. Unless the Association elects otherwise, the insurance purchased by the Association shall not cover claims against an Owner due to accidents occurring within his Unit, nor casualty or theft loss to the contents of an Owner's Unit. It shall be the obligation of the individual Unit Owner, if such Owner so desires, to purchase and pay for insurance as to all such and other risks not covered by insurance carried by the Association.
- 14.9 Benefit of Mortgagees. Certain provisions in this Section 14 are for the benefit of mortgagees of Units and may be enforced by such mortgagees.
- 14.10 Appointment of Insurance Trustee. The Board of Directors of the Association shall have the option in its discretion of appointing an Insurance Trustee hereunder. If the Association fails or elects not to appoint such Trustee, the Association, pursuant to Subsection 14.5 above, will

(Reserved for Clerk of Court)

perform directly all obligations imposed upon such Trustee by this Declaration. Fees and expenses of any Insurance Trustee are Common Expenses.

- 14.11 Presumption as to Damaged Property. In the event of a dispute or lack of certainty as to whether damaged property constitutes a Unit(s) or Common Elements, such property shall be presumed to be Common Elements.

15. Reconstruction or Repair After Fire or Other Casualty.

- 15.1 Determination to Reconstruct or Repair. Subject to the provisions of the immediately following paragraph, in the event of damage to or destruction of the Insured Property (and the Optional Property, if insurance has been obtained by the Association with respect thereto) as a result of fire or other casualty, the Board of Directors shall arrange for the prompt repair and restoration of the Insured Property (and the Optional Property, if insurance has been obtained by the Association with respect thereto) and the Association and/or Insurance Trustee (if appointed), as applicable, shall disburse the proceeds of all insurance policies to the contractors engaged in such repair and restoration in appropriate progress payments.

If 75% or more of the Insured Property (and the Optional Property, if insurance has been obtained by the Association with respect thereto) is substantially damaged or destroyed and if Unit Owners owning 80% of the applicable interests in the Common Elements duly and promptly resolve not to proceed with the repair or restoration thereof and a Majority of Institutional First Mortgagees approve such resolution, the Condominium Property will not be repaired and shall be subject to an action for partition instituted by the Association, any Unit Owner, mortgagee or lienor, as if the Condominium Property were owned in common, in which event the net proceeds of insurance resulting from such damage or destruction shall be divided among all the Unit Owners in proportion to their respective interests in the Common Elements (with respect to proceeds held for damage to the Insured Property other than that portion of the Insured Property lying within the boundaries of the Unit), and among affected Unit Owners in proportion to the damage suffered by each such affected Unit Owner, as determined in the sole discretion of the Association (with respect to proceeds held for damage to the Optional Property, if any, and/or that portion of the Insured Property lying within the boundaries of the Unit); provided, however, that no payment shall be made to a Unit Owner until there has first been paid off out of his share of such fund all mortgages and liens on his Unit in the order of priority of such mortgages and liens.

Whenever in this Section the words "promptly repair" are used, it shall mean that repairs are to begin not more than sixty (60) days from the date the Association holds, or the Insurance Trustee (if appointed) notifies the Board of Directors and Unit Owners that it holds, proceeds of insurance on account of such damage or destruction sufficient to pay the estimated cost of such work, or not more than ninety (90) days after the Association determines that, or the Insurance Trustee (if appointed) notifies the Board of Directors and the Unit Owners that, such proceeds of insurance are insufficient to pay the estimated costs of such work. The Insurance Trustee (if appointed) may rely upon a certificate of the Association made by its President and Secretary to determine whether or not the damaged property is to be reconstructed or repaired.

- 15.2 Plans and Specifications. Any reconstruction or repair must be made substantially in accordance with the plans and specifications for the original Improvements and then applicable building and other codes; or if not, then in accordance with the plans and specifications approved by the Board of Directors of the Association and then applicable building and other codes, and, if the damaged property which is to be altered is the Building or the Optional Property, by the Owners of not less than 80% of the applicable interests in the Common Elements, as well as the Owners of all Units and other portions of the Optional Property (and their respective mortgagees) the plans for which are to be altered.
- 15.3 Special Responsibility. If the damage is only to those parts of the Optional Property for which the responsibility of maintenance and repair is that of the respective Unit Owners, then the Unit Owners shall be responsible for all necessary reconstruction and repair, which shall be effected promptly and in accordance with guidelines established by the Board of Directors (unless insurance proceeds are held by the Association with respect thereto by reason of the purchase of optional insurance thereon, in which case the Association shall have the responsibility to reconstruct and repair the damaged Optional Property, provided the respective Unit Owners shall be individually responsible for any amount by which the cost of such repair or reconstruction exceeds the insurance proceeds held for such repair or reconstruction on a Unit by Unit basis, as

(Reserved for Clerk of Court)

determined in the sole discretion of the Association). In all other instances, the responsibility for all necessary reconstruction and repair shall be that of the Association.

- (a) Disbursement. The proceeds of insurance collected on account of a casualty, and the sums collected from Unit Owners on account of such casualty, shall constitute a construction fund which shall be disbursed in payment of the costs of reconstruction and repair in the following manner and order:
- (i) Association - Lesser Damage. If the amount of the estimated costs of reconstruction and repair which are the responsibility of the Association is less than \$100,000, then the construction fund shall be disbursed in payment of such costs upon the order of the Board of Directors of the Association; provided, however, that upon request to the Insurance Trustee (if appointed) by an Institutional First Mortgagee which is a beneficiary of an insurance policy, the proceeds of which are included in the construction fund, such fund shall be disbursed in the manner provided below for the reconstruction and repair of major damage.
  - (ii) Association - Major Damage. If the amount of the estimated costs of reconstruction and repair which are the responsibility of the Association is more than \$100,000, then the construction fund shall be disbursed in payment of such costs in the manner contemplated by Subsection 15.3(a)(i) above, but then only upon the further approval of an architect or engineer qualified to practice in Florida and employed by the Association to supervise the work.
  - (iii) Unit Owners. If there is a balance of insurance proceeds after payment of all costs of reconstruction and repair that are the responsibility of the Association, this balance may be used by the Association to effect repairs to the Optional Property (if not insured or if under-insured), or may be distributed to Owners of the Optional Property who have the responsibility for reconstruction and repair thereof. The distribution shall be in the proportion that the estimated cost of reconstruction and repair of such damage to each affected Unit Owner bears to the total of such estimated costs to all affected Unit Owners, as determined by the Board; provided, however, that no Unit Owner shall be paid an amount in excess of the estimated costs of repair for his portion of the Optional Property. Any and all proceeds shall only be used to effect repairs to the Optional Property, and if insufficient to complete such repairs, the Owners shall pay the deficit with respect to their portion of the Optional Property and promptly effect the repairs. Any balance remaining after such repairs have been effected shall be distributed to the affected Unit Owners and their mortgagees jointly as elsewhere herein contemplated.
  - (iv) Surplus. It shall be presumed that the first monies disbursed in payment of costs of reconstruction and repair shall be from insurance proceeds. If there is a balance in a construction fund after payment of all costs relating to the reconstruction and repair for which the fund is established, such balance shall be distributed to the beneficial owners of the fund in the manner elsewhere stated; except, however, that part of a distribution to an Owner which is not in excess of Assessments paid by such Owner into the construction fund shall not be made payable jointly to any mortgagee.
  - (v) Certificate. Notwithstanding the provisions herein, the Insurance Trustee shall not be required to determine whether or not sums paid by Unit Owners upon Assessments shall be deposited by the Association with the Insurance Trustee, nor to determine whether the disbursements from the construction fund are to be made upon the order of the Association alone or upon the additional approval of an architect, engineer or otherwise, nor whether a disbursement is to be made from the construction fund, nor to determine whether surplus funds to be distributed are less than the Assessments paid by Owners, nor to determine the payees nor the amounts to be paid. The Insurance Trustee may rely upon a certificate of the Association, made by its President and Secretary, as to any or all of such matters and stating that the sums to be paid are due and properly payable, and stating the names of the payees and the amounts to be paid.

(Reserved for Clerk of Court)

- 15.4 Assessments. If the proceeds of the insurance are not sufficient to defray the estimated costs of reconstruction and repair to be effected by the Association, or if at any time during reconstruction and repair, or upon completion of reconstruction and repair, the funds for the payment of the costs of reconstruction and repair are insufficient, Assessments shall be made against the Unit Owners in sufficient amounts to provide funds for the payment of such costs. Such Assessments on account of damage to the Insured Property shall be in proportion to all of the Owners' respective shares in the Common Elements, and on account of damage to the Optional Property, the Association shall charge the Owner (but shall not levy an Assessment) in proportion to the cost of repairing the damage suffered by each Owner thereof, as determined by the Association.
- 15.5 Benefit of Mortgagees. Certain provisions in this Section 15 are for the benefit of mortgagees of Units and may be enforced by any of them.
16. Condemnation.
- 16.1 Deposit of Awards with Insurance Trustee. The taking of portions of the Condominium Property or Association Property by the exercise of the power of eminent domain shall be deemed to be a casualty, and the awards for that taking shall be deemed to be proceeds from insurance on account of the casualty and shall be deposited with the Insurance Trustee. Even though the awards may be payable to Unit Owners, the Unit Owners shall deposit the awards with the Insurance Trustee; and in the event of failure to do so, in the discretion of the Board of Directors of the Association, a charge shall be made against a defaulting Unit Owner in the amount of his award, or the amount of that award shall be set off against the sums hereafter made payable to that Owner.
- 16.2 Determination Whether to Continue Condominium. Whether the Condominium will be continued after condemnation will be determined in the manner provided for determining whether damaged property will be reconstructed and repaired after casualty. For this purpose, the taking by eminent domain also shall be deemed to be a casualty.
- 16.3 Disbursement of Funds. If the Condominium is terminated after condemnation, the proceeds of the awards and special Assessments will be deemed to be insurance proceeds and shall be owned and distributed in the manner provided with respect to the ownership and distribution of insurance proceeds if the Condominium is terminated after a casualty. If the Condominium is not terminated after condemnation, the size of the Condominium will be reduced and the property damaged by the taking will be made usable in the manner provided below. The proceeds of the awards and special Assessments shall be used for these purposes and shall be disbursed in the manner provided for disbursement of funds by the Insurance Trustee (if appointed) after a casualty, or as elsewhere in this Section 16 specifically provided.
- 16.4 Unit Reduced but Habitable. If the taking reduces the size of a Unit and the remaining portion of the Unit can be made habitable (in the sole opinion of the Association), the award for the taking of a portion of the Unit shall be used for the following purposes in the order stated and the following changes shall be made to the Condominium:
- (a) Restoration of Unit. The Unit shall be made habitable. If the cost of the restoration exceeds the amount of the award, the additional funds required shall be charged to and paid by the Owner of the Unit.
  - (b) Distribution of Surplus. The balance of the award in respect of the Unit, if any, shall be distributed to the Owner of the Unit and to each mortgagee of the Unit, the remittance being made payable jointly to the Owner and such mortgagees.
  - (c) Adjustment of Shares in Common Elements. If the floor area of the Unit is reduced by the taking, the percentage representing the share in the Common Elements and of the Common Expenses and Common Surplus appurtenant to the Unit shall be reduced by multiplying the percentage of the applicable Unit prior to reduction by a fraction, the numerator of which shall be the area in square feet of the Unit after the taking and the denominator of which shall be the area in square feet of the Unit before the taking. The shares of all Unit Owners in the Common Elements, Common Expenses and Common Surplus shall then be restated as follows:
    - (i) add the total of all percentages of all Units after reduction as aforesaid (the "Remaining Percentage Balance"); and



(Reserved for Clerk of Court)

- (ii) divide each percentage for each Unit after reduction as aforesaid by the Remaining Percentage Balance.

The result of such division for each Unit shall be the adjusted percentage for such Unit.

16.5 Unit Made Uninhabitable. If the taking is of the entire Unit or so reduces the size of a Unit that it cannot be made habitable (in the sole opinion of the Association), the award for the taking of the Unit shall be used for the following purposes in the order stated and the following changes shall be made to the Condominium:

- (a) Payment of Award. The awards shall be paid first to the applicable Institutional First Mortgagees in amounts sufficient to pay off their mortgages in connection with each Unit which is not so habitable; second, to the Association for any due and unpaid Assessments; third, jointly to the affected Unit Owners and other mortgagees of their Units. In no event shall the total of such distributions in respect of a specific Unit exceed the market value of such Unit immediately prior to the taking. The balance, if any, shall be applied to repairing and replacing the Common Elements.
- (b) Addition to Common Elements. The remaining portion of the Unit, if any, shall become part of the Common Elements and shall be placed in a condition allowing, to the extent possible, for use by all of the Unit Owners in the manner approved by the Board of Directors of the Association; provided that if the cost of the work therefor shall exceed the balance of the fund from the award for the taking, such work shall be approved in the manner elsewhere required for capital improvements to the Common Elements.
- (c) Adjustment of Shares. The shares in the Common Elements, Common Expenses and Common Surplus appurtenant to the Units that continue as part of the Condominium shall be adjusted to distribute the shares in the Common Elements, Common Expenses and Common Surplus among the reduced number of Unit Owners (and among reduced Units). This shall be effected by restating the shares of continuing Unit Owners as follows:
  - (i) add the total of all percentages of all Units of continuing Owners prior to this adjustment, but after any adjustments made necessary by Subsection 16.4(c) hereof (the "Percentage Balance"); and
  - (ii) divide the percentage of each Unit of a continuing Owner prior to this adjustment, but after any adjustments made necessary by Subsection 16.4(c) hereof, by the Percentage Balance.

The result of such division for each Unit shall be the adjusted percentage for such Unit.

- (d) Assessments. If the balance of the award (after payments to the Unit Owner and such Owner's mortgagees as above provided) for the taking is not sufficient to alter the remaining portion of the Unit for use as a part of the Common Elements, the additional funds required for such purposes shall be raised by Assessments against all of the Unit Owners who will continue as Owners of Units after the changes in the Condominium effected by the taking. The Assessments shall be made in proportion to the applicable percentage shares of those Owners after all adjustments to such shares effected pursuant hereto by reason of the taking.
- (e) Arbitration. If the market value of a Unit prior to the taking cannot be determined by agreement between the Unit Owner and mortgagees of the Unit and the Association within 30 days after notice of a dispute by any affected party, such value shall be determined by arbitration in accordance with the then existing rules of the American Arbitration Association, except that the arbitrators shall be two appraisers appointed by the American Arbitration Association who shall base their determination upon an average of their appraisals of the Unit. A judgment upon the decision rendered by the arbitrators may be entered in any court of competent jurisdiction in accordance with the Florida Arbitration Code. The cost of arbitration proceedings shall be assessed against all Unit Owners, including Owners who will not continue after the taking, in proportion to the applicable percentage shares of such Owners as they exist prior to the adjustments to such shares effected pursuant hereto by reason of the taking. Notwithstanding the foregoing, nothing contained herein shall limit or abridge the remedies of Unit Owners provided in Sections 718.303 and 718.506, F.S.

(Reserved for Clerk of Court)

- 16.6 Taking of Common Elements. Awards for the taking of Common Elements shall be used to render the remaining portion of the Common Elements usable in the manner approved by the Board of Directors of the Association; provided, that if the cost of such work shall exceed the balance of the funds from the awards for the taking, the work shall be approved in the manner elsewhere required for capital improvements to the Common Elements. The balance of the awards for the taking of Common Elements, if any, shall be distributed to the Unit Owners in the shares in which they own the Common Elements after adjustments to these shares effected pursuant hereto by reason of the taking. If there is a mortgage on a Unit, the distribution shall be paid jointly to the Owner and the mortgagees of the Unit.
- 16.7 Amendment of Declaration. The changes in Units, in the Common Elements and in the ownership of the Common Elements and share in the Common Expenses and Common Surplus that are effected by the taking shall be evidenced by an amendment to this Declaration of Condominium that is only required to be approved by, and executed upon the direction of, a majority of all Directors of the Association.
17. Occupancy and Use Restrictions. In order to provide for congenial occupancy of the Condominium and Association Property and for the protection of the values of the Units, the use of the Condominium Property shall be restricted to and shall be in accordance with the following provisions:
- 17.1 Occupancy. Each Unit shall be used as a residence only, except as otherwise herein expressly provided, all in accordance with all applicable City, County, State and Federal codes, ordinances and regulations. The provisions of this Subsection 17.1 shall not be applicable to Units used by the Developer, (which it has the authority to do without Unit Owner consent or approval, and without payment of consideration), for model apartments, guest suites, sales, re-sales and/or leasing offices and/or for the provision of management, construction, development and/or financial services.
- 17.2 Children. Children shall be permitted to be occupants of Units.
- 17.3 Pet Restrictions. Domesticated dogs and/or cats may be maintained in a Unit provided such pets are: (a) permitted to be so kept by applicable laws and regulations, (b) not left unattended on balconies or in lanai areas, (c) generally, not a nuisance to residents of other Units or of neighboring buildings and (d) not a pit bull or other breed considered to be dangerous by the Board of Directors; provided that neither the Board nor the Association shall be liable for any personal injury, death or property damage resulting from a violation of the foregoing and any occupant of a Unit committing such a violation shall fully indemnify and hold harmless the Board of Directors, the Developer, each Unit Owner, and the Association in such regard. Unit Owners must pick up all solid wastes of their pets and dispose of such wastes appropriately. All pets (including cats) must be kept on a leash of a length that affords reasonable control over the pet at all times when outside the Unit or enclosed patio. Any landscaping damage or other damage to the Common Elements caused by a Unit Owner's pet must be promptly repaired by the Unit Owner. The Association retains the right to effect said repairs and charge the Unit Owner therefor. Pets shall only be walked or taken upon those portions of the Common Elements designated by the Association, if any, from time to time for such purposes. Pets shall only be in the hallways of the Building as a means of direct ingress or egress to and from its Owner's Unit and the exterior of the Building. A violation of the pet regulations shall entitle the Association to all of its rights and remedies, including, the right to fine Unit Owners and/or to require any pet to be permanently removed from the Condominium Property.
- 17.4 Garbage. No Unit Owner shall be permitted to keep any rubbish, refuse and/or trash in places other than those areas specifically provided for within the Common Elements and/or other portions of the Condominium Property. The provisions of this Subsection shall not apply to the Developer in connection with any and all construction and/or development activities.
- 17.5 Alterations. Without limiting the generality of Subsection 9.1 hereof, but subject to Section 11 hereof, no Unit Owner shall cause or allow improvements or changes to any Unit, Limited Common Elements appurtenant thereto, Common Elements or Association Property, including, but not limited to, painting or other decorating of any nature, installing any electrical wiring, television antenna, satellite dishes, electronic devices, transmitting and/or receiving equipment, machinery, or air-conditioning units, which in any manner change the appearance of any portion of the Building, without obtaining the prior written consent of the Association (in the manner specified in Subsection 9.1 hereof). Notwithstanding the provisions of Section 9.1 above, any Unit Owner may display one portable, removable United States flag in a respectful way, and, on

(Reserved for Clerk of Court)

Armed Forces Day, Memorial Day, Flag Day, Independence Day and Veterans day, may display in a respectful way portable, removable official flags, not larger than 4<sup>1</sup>/<sub>2</sub> feet by 6 feet, that represent the United States Army, Navy, Air Force, Marine Corps or Coast Guard.

- 17.6 Use of Common Elements and Association Property. The Common Elements and Association Property shall be used only for furnishing of the services and facilities for which they are reasonably suited and which are incident to the use and occupancy of Units. In that regard, each Unit Owner, by acceptance of a deed for a Unit, thereby covenants and agrees that it is the intention of the Developer that the stairwells of the Building are intended for ingress and egress in the event of emergency only, and as such are constructed and left unfinished solely as to be functional for said purpose, without regard to the aesthetic appearance of said stairwells. Similarly, any garage and the utility pipes serving the Condominium are intended solely for functional purposes, and as such will be left unfinished without regard to the aesthetic appearance of same. The foregoing is not intended to prohibit the use of the stairwells, any garage, and utility pipes for any other purpose.
- 17.7 Nuisances. No nuisances (as defined by the Association) shall be allowed on the Condominium or Association Property, nor shall any use or practice be allowed which is a source of annoyance to occupants of Units or which interferes with the peaceful possession or proper use of the Condominium and/or Association Property by its residents, occupants or members. No activity specifically permitted by this Declaration shall be deemed a nuisance.
- 17.8 No Improper Uses. No improper, offensive, hazardous or unlawful use shall be made of the Condominium or Association Property or any part thereof, and all valid laws, zoning ordinances and regulations of all governmental bodies having jurisdiction thereover shall be observed. Violations of laws, orders, rules, regulations or requirements of any governmental agency having jurisdiction thereover, relating to any portion of the Condominium and/or Association Property, shall be corrected by, and at the sole expense of, the party obligated to maintain or repair such portion of the Condominium Property, as elsewhere herein set forth. Notwithstanding the foregoing and any provisions of this Declaration, the Articles of Incorporation or By-Laws, the Association shall not be liable to any person(s) for its failure to enforce the provisions of this Subsection 17.8. No activity specifically permitted by this Declaration shall be deemed to be a violation of this Section 17.8.
- 17.9 Leases. Leasing of Units or portions thereof may, at the discretion of the Association, be subject to the prior written approval of the Association. In any event, every lease shall be in writing and shall specifically provide (or, if it does not, shall be automatically deemed to provide) that a material condition of the lease shall be the tenant's full compliance with the covenants, terms, conditions and restrictions of this Declaration (and all Exhibits hereto), and with any and all rules and regulations adopted by the Association from time to time (before or after the execution of the lease and/or any modifications, renewals or extensions of same). No lease of a Unit shall be for a period of less than six (6) months and a day. The Unit Owner will be jointly and severally liable with the tenant to the Association for any amount which is required by the Association to repair any damage to the Common Elements resulting from acts or omissions of tenants (as determined in the sole discretion of the Association) and to pay any claim for injury or damage to property caused by the negligence of the tenant. All leases shall be subordinate to any lien filed by the Condominium Association, whether prior or subsequent to such lease. Association may charge a fee in connection with the approval of any lease, sublease, or other transfer of a Unit requiring approval, provided, however that such fee may not exceed \$100 per applicant other than husband/wife or parent/dependent child, which are considered one applicant, and provided further, that if the lease or sublease is a renewal of a lease or sublease with the same lessee or sublessee, no charge shall be made. If so required by the Association, a Unit Owner wishing to lease a Unit shall require a prospective lessee to place in escrow with the Association a reasonable sum, not to exceed the equivalent of one month's rental, which may be used by the Association to repair any damage to the Common Elements and/or Association Property resulting from acts or omissions of tenants (as determined in the sole discretion of the Association). Payment of interest, claims against the deposit, refunds and disputes regarding the disposition of the deposit shall be handled in the same fashion as provided in Part II of Chapter 83, Florida Statutes. When a Unit is leased, a tenant shall have all use rights in Association Property and those Common Elements otherwise readily available for use generally by Unit Owners, and the Owner of the leased Unit shall not have such rights, except as a guest, unless such rights are waived in writing by the tenant. Nothing herein shall interfere with the access rights of the Unit Owner as a landlord pursuant to Chapter 83, Florida Statutes. The Association shall have the right to adopt rules to prohibit dual usage by a Unit Owner and a tenant of Association Property and Common Elements otherwise readily available for use generally by Owners.

(Reserved for Clerk of Court)

- 17.10 Weight, Sound and other Restrictions. Unless installed by the Developer, or prior to the creation of the Condominium or meeting the sound insulation specifications set forth herein (as same may be modified from time to time), hard and/or heavy surface floor coverings, such as tile, marble, wood, and the like will be permitted only in foyers, kitchens and bathrooms. Although prior Board approval is not required, the installation of any hard and/or heavy surface floor coverings must meet the following specifications: the aggregate sound isolation and acoustical treatment shall carry a minimum Sound Transmission Classification (STC) of 48, and the installation of the foregoing insulation materials shall be performed in a manner that provides proper mechanical isolation of the flooring materials from any rigid part of the building structure, whether of the concrete subfloor (vertical transmission) or adjacent walls and fittings (horizontal transmission) and must be installed prior to the Unit being occupied. Notwithstanding the foregoing, the floor coverings (and insulation and adhesive material therefor) installed on any balcony, terrace, patio and/or lanai shall not exceed a thickness that will result in the finish level of the balconies, terraces, patios and/or lanais being above the bottom of the scuppers. Also, the installation of any improvement or heavy object must be submitted to and approved by the Board, and be compatible with the overall structural design of the building. All areas within a Unit other than foyers, kitchens and bathrooms are to receive sound absorbent, less dense floor coverings, such as carpeting or hard surface floor coverings meeting the specifications described above. The Board will have the right to specify the exact material to be used on balconies, terraces, patios and/or lanais. Any use guidelines set forth by the Association shall be consistent with good design practices for the waterproofing and overall structural design of the Building. Owners will be held strictly liable for violations of these restrictions and for all damages resulting therefrom and the Association has the right to require immediate removal of violations. **Applicable warranties of the Developer, if any, shall be voided by violations of these restrictions and requirements. Each Owner agrees that sound transmission in a multi-story building such as the Condominium is very difficult to control, and that noises from adjoining or nearby Units and or mechanical equipment can often be heard in another Unit. The Developer does not make any representation or warranty as to the level of sound transmission between and among Units and the other portions of the Condominium Property, and each Owner shall be deemed to waive and expressly release any such warranty and claim for loss or damages resulting from sound transmission.**
- 17.11 Mitigation of Dampness and Humidity. No Unit Owner shall install, within his or her Unit, or upon the Common Elements or Association Property, non-breathable wall-coverings or low-permeance paints. Additionally, any and all built-in casework, furniture, and or shelving in a Unit must be installed over floor coverings to allow air space and air movement and shall not be installed with backboards flush against any gypsum board wall. Additionally, all Unit Owners, whether or not occupying the Unit, shall periodically run the air conditioning system to maintain the Unit temperature, whether or not occupied, at 78°F, to minimize humidity in the Unit. While the foregoing are intended to minimize the potential development of molds, fungi, mildew and other mycotoxins, each Owner understands and agrees that there is no method for completely eliminating the development of molds or mycotoxins. The Developer does not make any representations or warranties regarding the existence or development of molds or mycotoxins and each Owner shall hold Developer harmless and be deemed to waive and expressly release any such warranty and claim for loss or damages resulting from the existence and/or development of same. In furtherance of the rights of the Association as set forth in Section 11.1(a) above, in the event that the Association reasonably believes that the provisions of this Section 17.11 are not being complied with, then, the Association shall have the right (but not the obligation) to enter the Unit (without requiring the consent of the Owner or any other party) to turn on the air conditioning in an effort to cause the temperature of the Unit to be maintained as required hereby (with all utility consumption costs to be paid and assumed by the Unit Owner). To the extent that electric service is not then available to the Unit, the Association shall have the further right, but not the obligation (without requiring the consent of the Owner or any other party) to connect electric service to the Unit (with the costs thereof to be borne by the Unit Owner, or if advanced by the Association, to be promptly reimbursed by the Owner to the Association, with all such costs to be deemed Charges hereunder).
- 17.12 Exterior Improvements. Without limiting the generality of Subsections 9.1 or 17.5 hereof, but subject to any provision of this Declaration specifically permitting same, no Unit Owner shall cause anything to be affixed or attached to, hung, displayed or placed on the exterior walls, doors, balconies or windows of the Building (including, but not limited to, awnings, signs, storm shutters, satellite dishes, screens, window tinting, furniture, fixtures and equipment), without the prior written consent of the Association. Notwithstanding the foregoing, any Unit Owner may display one portable removable United States flag in a respectful way.

(Reserved for Clerk of Court)

- 17.13 Association Access to Units. In order to facilitate access to Units by the Association for the purposes enumerated in Subsection 11.1(a) hereof, it shall be the responsibility of all Unit Owners to deliver a set of keys to their respective Units (or to otherwise make access available) to the Association for use in the performance of its functions. No Owner shall change the locks to his or her Unit (or otherwise preclude access to the Association) without so notifying the Association and delivering to the Association a new set of keys (or otherwise affording access) to such Unit.
- 17.14 Hurricane Shutters. The Board of Directors shall, from time to time, establish hurricane shutter specifications which comply with the applicable building code, and establish permitted colors, styles and materials for hurricane shutters. Subject to the provisions of Subsection 9.1 above, the Association shall approve the installation or replacement of hurricane shutters conforming with the Board's specifications. The Board may, with the approval of a majority of voting interests in the Condominium, install hurricane shutters, and may (without requiring approval of the membership) maintain, repair or replace such approved shutters, whether on or within Common Elements, Limited Common Elements, Units or Association Property; provided, however, that if laminated glass, in accordance with all applicable building codes and standards, architecturally designed to serve as hurricane protection, is installed, the Board may not install hurricane shutters in accordance with this provision. All shutters shall remain open unless and until a storm watch or storm warning is announced by the National Weather Center or other recognized weather forecaster. A Unit Owner or occupant who plans to be absent during all or any portion of the hurricane season must prepare his or her Unit prior to departure by designating a responsible firm or individual to care for the Unit should a hurricane threaten the Unit or should the Unit suffer hurricane damage, and furnishing the Association with the name(s) of such firm or individual. Such firm or individual shall be subject to the approval of the Association.
- To the extent that the Association determines to provide hurricane shutters for any portion of the condominium property, the Association shall be solely responsible for the installation of any hurricane shutters from time to time and the costs associated therewith shall be deemed a part of the Common Expenses of the Condominium that are included in the Assessments payable by Unit Owners. The obligations of the Association assumed hereby shall include, without limitation, development of appropriate plans to allow for the timely installation of the shutters, and all obligations with respect to the repair, replacement and/or upgrade of the shutters. Developer shall have no obligations with respect to the installation of the shutters, and/or for the repair, replacement and/or upgrade of the shutters.
- 17.15 Relief by Association. The Association shall have the power (but not the obligation) to grant relief in particular circumstances from the provisions of specific restrictions contained in this Section 17 for good cause shown, as determined by the Association in its sole discretion.
- 17.16 Effect on Developer. Subject to the following exceptions, the restrictions and limitations set forth in this Section 17 shall not apply to the Developer nor to Units owned by the Developer. The Developer shall not be exempt from the restrictions, if any, relating to requirements that leases or lessees be approved by the Association, pet restrictions, occupancy of Units based on age and vehicular restrictions, except as such vehicular restrictions relate to the Developer's construction, maintenance, sales, re-sales, leasing and other marketing and financing activities, which activities the Developer can perform without the prior consent of the Unit Owners.
18. Compliance and Default. The Association, each Unit Owner, occupant of a Unit, tenant and other invitee of a Unit Owner shall be governed by and shall comply with the terms of this Declaration and all exhibits annexed hereto, and the rules and regulations adopted pursuant to those documents, as the same may be amended from time to time and the provisions of all of such documents shall be deemed incorporated into any lease of a Unit whether or not expressly stated in such lease. The Association (and Unit Owners, if appropriate) shall be entitled to the following relief in addition to the remedies provided by the Act:
- 18.1 Mandatory Nonbinding Arbitration of Disputes. Prior to the institution of court litigation, the parties to a Dispute shall petition the Division for non-binding arbitration. The arbitration shall be conducted according to rules promulgated by the Division and before arbitrators employed by the Division. The filing of a petition for arbitration shall toll the applicable statute of limitation for the applicable Dispute, until the arbitration proceedings are completed. Any arbitration decision shall be presented to the parties in writing, and shall be deemed final if a complaint for trial de novo is not filed in a court of competent jurisdiction in which the Condominium is located within thirty (30) days following the issuance of the arbitration decision. The prevailing party in the arbitration proceeding shall be awarded the costs of the arbitration, and attorneys' fees and costs incurred in connection with the proceedings. The party who files a complaint for a trial de novo shall be charged the other party's arbitration costs, courts costs and other reasonable costs,

(Reserved for Clerk of Court)

including, without limitation, attorneys' fees, investigation expenses and expenses for expert or other testimony or evidence incurred after the arbitration decision, if the judgment upon the trial de novo is not more favorable than the arbitration decision. If the judgment is more favorable, the party who filed a complaint for trial de novo shall be awarded reasonable court costs and attorneys' fees. Any party to an arbitration proceeding may enforce an arbitration award by filing a petition in a court of competent jurisdiction in which the Condominium is located. A petition may not be granted unless the time for appeal by the filing of a complaint for a trial de novo has expired. If a complaint for a trial de novo has been filed, a petition may not be granted with respect to an arbitration award that has been stayed. If the petition is granted, the petitioner may recover reasonable attorneys' fees and costs incurred in enforcing the arbitration award.

18.2 Negligence and Compliance. A Unit Owner and/or tenant of a Unit shall be liable for the expense of any maintenance, repair or replacement made necessary by his negligence or by that of any member of his family or his or their guests, employees, agents or lessees, but only to the extent such expense is not met by the proceeds of insurance actually collected in respect of such negligence by the Association. In the event a Unit Owner, tenant or occupant fails to maintain a Unit or fails to cause such Unit to be maintained, or fails to observe and perform all of the provisions of the Declaration, the By-Laws, the Articles of Incorporation of the Association, applicable rules and regulations, or any other agreement, document or instrument affecting the Condominium Property or administered by the Association, in the manner required, the Association shall have the right to proceed in equity to require performance and/or compliance, to impose any applicable fines (in accordance with the provisions of Section 18.3 below), to sue at law for damages, and to charge the Unit Owner for the sums necessary to do whatever work is required to put the Unit Owner or Unit in compliance, provided, however, that nothing contained in this Subsection 18.2 shall authorize the Association to enter a Unit to enforce compliance. In any proceeding arising because of an alleged failure of a Unit Owner, a tenant or the Association to comply with the requirements of the Act, this Declaration, the exhibits annexed hereto, or the rules and regulations adopted pursuant to said documents, as the same may be amended from time to time, the prevailing party shall be entitled to recover the costs of the proceeding and such reasonable attorneys' fees (including appellate attorneys' fees). A Unit Owner prevailing in an action with the Association, in addition to recovering his reasonable attorneys' fees, may recover additional amounts as determined by the court to be necessary to reimburse the Unit Owner for his share of Assessments levied by the Association to fund its expenses of the litigation.

18.3 Fines. In addition to any and all other remedies available to the Association, in the sole discretion of the Board of Directors of the Association, a fine or fines may be imposed upon an Owner for failure of an Owner, his family, guests, invitees, lessees or employees, to comply with any covenant, restriction, rule or regulation herein or Articles of Incorporation, By-Laws or Rules and Regulations of the Association, provided the following procedures are adhered to:

- (a) Notice: The party against whom the fine is sought to be levied shall be afforded an opportunity for hearing after reasonable notice of not less than fourteen (14) days and said notice shall include: (i) a statement of the date, time and place of the hearing; (ii) a statement of the provisions of the Declaration, By-Laws, Articles or rules which have allegedly been violated; and (iii) a short and plain statement of the matters asserted by the Association.
- (b) Hearing: The non-compliance shall be presented to a committee of other Unit Owners, who shall hear reasons why penalties should not be imposed. The party against whom the fine may be levied shall have an opportunity to respond, to present evidence, and to provide written and oral argument on all issues involved and shall have an opportunity at the hearing to review, challenge, and respond to any material considered by the committee. A written decision of the committee shall be submitted to the Owner or occupant by not later than twenty-one (21) days after the meeting.
- (c) Fines: The Board of Directors may impose fines against the applicable Unit up to the maximum amount permitted by law from time to time.
- (d) Violations: Each separate incident which is grounds for a fine shall be the basis of one separate fine. In the case of continuing violations, each continuation of same after a notice thereof is given shall be deemed a separate incident.
- (e) Payment of Fines: Fines shall be paid not later than thirty (30) days after notice of the imposition thereof.

(Reserved for Clerk of Court)

- (f) Application of Fines: All monies received from fines shall be allocated as directed by the Board of Directors.
- (g) Non-exclusive Remedy: These fines shall not be construed to be exclusive and shall exist in addition to all other rights and remedies to which the Association may be otherwise legally entitled; however, any penalty paid by the offending Owner or occupant shall be deducted from or offset against any damages which the Association may otherwise be entitled to recover by law from such Owner or occupant.
19. Termination of Condominium. The Condominium shall continue until (a) terminated by casualty loss, condemnation or eminent domain, as more particularly provided in this Declaration, or (b) such time as withdrawal of the Condominium Property from the provisions of the Act is authorized by a vote of Owners owning at least 80% of the applicable interests in the Common Elements and by the Institutional First Mortgagees of Units to which at least sixty-seven percent (67%) of the voting interests of Units subject to mortgages held by Institutional First Mortgagees are appurtenant. In the event such withdrawal is authorized as aforesaid, and provided that the Board first notifies the Division of an intended withdrawal, the Condominium Property shall be subject to an action for partition by any Unit Owner, mortgagee or lienor as if owned in common in which event the net proceeds of the partition sale shall be divided among all Unit Owners in proportion to their respective interests in the Common Elements, provided, however, that no payment shall be made to a Unit Owner until there has first been paid off out of his share of such net proceeds all mortgages and liens on his Unit in the order of their priority. The termination of the Condominium, as aforesaid, shall be evidenced by a certificate of the Association executed by its President and Secretary, certifying as to the basis of the termination and said certificate shall be recorded among the public records of the County. The Association shall, within thirty (30) business days following such recordation, provide the Division with a copy of such recorded certificate.
20. Additional Rights of Mortgagees and Others.
- 20.1 Availability of Association Documents. The Association shall have current and updated copies of the following available for inspection by Institutional First Mortgagees during normal business hours or under other reasonable circumstances as determined by the Board: (a) this Declaration; (b) the Articles; (c) the By-Laws; (d) the rules and regulations of the Association; and (e) the books, records and financial statements of the Association.
- 20.2 Amendments. Subject to the other provisions of this Declaration and except as provided elsewhere to the contrary, an amendment directly affecting any of the following shall require the approval of a Majority of Institutional First Mortgagees: (a) voting rights; (b) a reallocation of responsibility for Common Expenses or a change in the priority of assessment liens; (c) reductions in reserves for maintenance, repair and replacement of Common Elements and/or Association Property; (d) responsibility for maintenance and repairs; (e) reallocation of interests in the Common Elements (including Limited Common Elements) or rights to their use; (f) redefinition of Unit boundaries; (g) conversion of Units into Common Elements or Common Elements into Units; (h) expansion or contraction of the Condominium; (i) hazard or fidelity insurance requirements; (j) imposition of restrictions on leasing of units; (k) imposition of restrictions on the selling or transferring of title to Units; (l) restoration or repair of the Condominium after a casualty or partial condemnation; (m) any action to terminate the Condominium after casualty or condemnation; and (n) any provision that expressly benefits mortgage holders, insurers or guarantors as a class. In accordance with Section 718.110(11), Florida Statutes, any consent required of a mortgagee may not be unreasonably withheld.
- 20.3 Notices. Any holder, insurer or guarantor of a mortgage on a Unit shall have, if first requested in writing, the right to timely written notice of:
- (a) any condemnation or casualty loss affecting a material portion of the Condominium and/or Association Property or the affected mortgaged Unit;
- (b) a sixty (60) day delinquency in the payment of the Assessments on a mortgaged Unit;
- (c) the occurrence of a lapse, cancellation or material modification of any insurance policy or fidelity bond maintained by the Association;
- (d) any proposed action which requires the consent of a specified number of mortgage holders.

(Reserved for Clerk of Court)

- 20.4 Additional Rights. Institutional First Mortgagees shall have the right, upon written request to the Association, to: (a) receive a copy of an audited financial statement of the Association for the immediately preceding fiscal year if such statements were prepared; and (b) receive notices of and attend Association meetings.
21. Covenant Running With the Land. All provisions of this Declaration, the Articles, By-Laws and applicable rules and regulations of the Association, shall, to the extent applicable and unless otherwise expressly herein or therein provided to the contrary, be perpetual and be construed to be covenants running with the Land and with every part thereof and interest therein, and all of the provisions hereof and thereof shall be binding upon and inure to the benefit of the Developer and subsequent owner(s) of the Land or any part thereof, or interest therein, and their respective heirs, personal representatives, successors and assigns, but the same are not intended to create nor shall they be construed as creating any rights in or for the benefit of the general public. All present and future Unit Owners, tenants and occupants of Units shall be subject to and shall comply with the provisions of this Declaration, the Articles, By-Laws and applicable rules and regulations, all as they may be amended from time to time. The acceptance of a deed or conveyance, or the entering into of a lease, or the entering into occupancy of any Unit, shall constitute an adoption and ratification of the provisions of this Declaration, and the Articles, By-Laws and applicable rules and regulations of the Association, all as they may be amended from time to time, including, but not limited to, a ratification of any appointments of attorneys-in-fact contained herein
22. Disclaimer of Warranties. Notwithstanding that this Condominium is a conversion of previously occupied premises, Developer has elected to warrant the improvements solely to the extent provided in Section 718.618 Florida Statutes. Except only for those warranties provided in Section 718.618, Florida Statutes (and only to the extent applicable and not yet expired), and Section 718.203, Florida Statutes (and only to the extent applicable and not yet expired), to the maximum extent lawful Developer hereby disclaims any and all and each and every express or implied warranties, whether established by statutory, common, case law or otherwise, as to the design, construction, sound and/or odor transmission, existence and/or development of molds, mildew, toxins or fungi, furnishing and equipping of the Condominium Property, including, without limitation, any implied warranties of habitability, fitness for a particular purpose or merchantability, compliance with plans, all warranties imposed by statute (other than those imposed by Sections 718.618 and 718.203, Florida Statutes, and then only to the extent applicable and not yet expired) and all other express and implied warranties of any kind or character. Developer has not given and the Unit Owner has not relied on or bargained for any such warranties. Each Unit Owner recognizes and agrees that the Unit and Condominium are not new construction. Each Unit Owner, by accepting a deed to a Unit, or other conveyance thereof, shall be deemed to represent and warrant to Developer that in deciding to acquire the Unit, the Unit Owner relied solely on such Unit Owner's independent inspection of the Unit and the Condominium as well as the conversion inspection reports included in the Prospectus. The Unit Owner has not received nor relied on any warranties and/or representations from Developer of any kind, other than as expressly provided herein.

As to any implied warranty which cannot be disclaimed entirely, all secondary, incidental and consequential damages are specifically excluded and disclaimed (claims for such secondary, incidental and consequential damages being clearly unavailable in the case of implied warranties which are disclaimed entirely above).

Further, given the climate and humid conditions in Florida, molds, mildew, toxins and fungi may exist and/or develop within the Unit and/or Condominium Property. Each Owner is hereby advised that certain molds, mildew, toxins and/or fungi may be, or if allowed to remain for a sufficient period may become, toxic and potentially pose a health risk. By acquiring title to a Unit, each Owner shall be deemed to have assumed the risks associated with molds, mildew, toxins and/or fungi and to have released the Developer from any and liability resulting from same.

Lastly, each Owner, by acceptance of a deed or other conveyance of a Unit, understands and agrees that there are various methods for calculating the square footage of a Unit, and that depending on the method of calculation, the quoted square footage of the Unit may vary by not more than a nominal amount. Additionally, as a result of in the field construction, other permitted changes to the Unit, and settling and shifting of improvements, actual square footage of a Unit may also be affected. By accepting title to a Unit, the applicable Owner(s) shall be deemed to have conclusively agreed to accept the size and dimensions of the Unit, regardless of any variances in the square footage from that which may have been disclosed at any time prior to closing, whether included as part of Developer's promotional materials or otherwise. Without limiting the generality of this Section 23, Developer does not make any representation or warranty as to the actual size, dimensions (including



(Reserved for Clerk of Court)

ceiling heights) or square footage of any Unit, and each Owner shall be deemed to have fully waived and released any such warranty and claims for losses or damages resulting from any variances between any represented or otherwise disclosed square footage and the actual square footage of the Unit. Notwithstanding the foregoing, nothing herein shall excuse the Developer from any liability under, or compliance with the provisions of Section 718.506, Florida Statutes.

23. Additional Provisions.

- 23.1 Notices. All notices to the Association required or desired hereunder or under the By-Laws of the Association shall be sent by certified mail (return receipt requested) to the Association in care of its office at the Condominium, or to such other address as the Association may hereafter designate from time to time by notice in writing to all Unit Owners. Except as provided specifically in the Act, all notices to any Unit Owner shall be sent by first class mail to the Condominium address of such Unit Owner, or such other address as may have been designated by him from time to time, in writing, to the Association. All notices to mortgagees of Units shall be sent by first class mail to their respective addresses, or such other address as may be designated by them from time to time, in writing to the Association. All notices shall be deemed to have been given when mailed in a postage prepaid sealed wrapper, except notices of a change of address, which shall be deemed to have been given when received, or 5 business days after proper mailing, whichever shall first occur.
- 23.2 Interpretation. Except where otherwise provided herein, the Board of Directors of the Association shall be responsible for interpreting the provisions hereof and of any of the Exhibits attached hereto. Such interpretation shall be binding upon all parties unless wholly unreasonable. An opinion of legal counsel that any interpretation adopted by the Association is not unreasonable shall conclusively establish the validity of such interpretation.
- 23.3 Mortgagees. Anything herein to the contrary notwithstanding, the Association shall not be responsible to any mortgagee or lienor of any Unit hereunder, and may assume the Unit is free of any such mortgages or liens, unless written notice of the existence of such mortgage or lien is received by the Association.
- 23.4 Exhibits. There is hereby incorporated in this Declaration all materials contained in the Exhibits annexed hereto, except that as to such Exhibits, any conflicting provisions set forth therein as to their amendment, modification, enforcement and other matters shall control over those hereof.
- 23.5 Signature of President and Secretary. Wherever the signature of the President of the Association is required hereunder, the signature of a vice-president may be substituted therefor, and wherever the signature of the Secretary of the Association is required hereunder, the signature of an assistant secretary may be substituted therefor, provided that the same person may not execute any single instrument on behalf of the Association in two separate capacities. Signatures of the President and Secretary on copies of any document required hereunder which is transmitted by facsimile machine shall be deemed originals for all purposes hereunder, and shall be binding upon the parties thereto.
- 23.6 Governing Law. Should any dispute or litigation arise between any of the parties whose rights or duties are affected or determined by this Declaration, the Exhibits annexed hereto or applicable rules and regulations adopted pursuant to such documents, as the same may be amended from time to time, said dispute or litigation shall be governed by the laws of the State of Florida.
- 23.7 Severability. The invalidity in whole or in part of any covenant or restriction, or any section, Subsection, sentence, paragraph, clause, phrase or word, or other provision of this Declaration, the Exhibits annexed hereto, or applicable rules and regulations adopted pursuant to such documents, as the same may be amended from time to time, shall not affect the validity of the remaining portions thereof which shall remain in full force and effect.
- 23.8 Waiver. The failure of the Association or any Unit Owner to enforce any covenant, restriction or other provision of the Act, this Declaration, the exhibits annexed hereto, or the rules and regulations adopted pursuant to said documents, as the same may be amended from time to time, shall not constitute a waiver of their right to do so thereafter.

(Reserved for Clerk of Court)

- 23.9 Ratification. Each Unit Owner, by reason of having acquired ownership (whether by purchase, gift, operation of law or otherwise), and each occupant of a Unit, by reason of his occupancy, shall be deemed to have acknowledged and agreed that all of the provisions of this Declaration, and the Articles and By-Laws of the Association, and applicable rules and regulations, are fair and reasonable in all material respects.
  
- 23.10 Execution of Documents; Attorney-in-Fact. Without limiting the generality of other Sections of this Declaration and without such other Sections limiting the generality hereof, each Owner, by reason of the acceptance of a deed to such Owner's Unit, hereby agrees to execute, at the request of the Developer, all documents or consents which may be required by all governmental agencies to allow the Developer and its affiliates to complete the plan of development of the Condominium as such plan may be hereafter amended, and each such Owner further appoints hereby and thereby the Developer as such Owner's agent and attorney-in-fact to execute, on behalf and in the name of such Owners, any and all of such documents or consents. This Power of attorney is irrevocable and coupled with an interest. The provisions of this Section may not be amended without the consent of the Developer.
  
- 23.11 Gender; Plurality. Wherever the context so permits, the singular shall include the plural, the plural shall include the singular, and the use of any gender shall be deemed to include all or no genders.
  
- 23.12 Captions. The captions herein and in the Exhibits annexed hereto are inserted only as a matter of convenience and for ease of reference and in no way define or limit the scope of the particular document or any provision thereof.
  
- 23.13 Liability. Notwithstanding anything contained herein or in the Articles of Incorporation, By-laws, any rules or regulations of the Association or any other document governing or binding the Association (collectively, the "Association Documents"), the Association, except to the extent specifically provided to the contrary herein, shall not be liable or responsible for, or in any manner be a guarantor or insurer of, the health, safety or welfare of any Owner, occupant or user of any portion of the Condominium and/or Association Property including, without limitation, Owners and their guests, invitees, agents, servants, contractors or subcontractors or for any property of any such persons. Without limiting the generality of the foregoing:
  - (a) it is the express intent of the Association Documents that the various provisions thereof which are enforceable by the Association and which govern or regulate the uses of the properties have been written, and are to be interpreted and enforced, for the sole purpose of enhancing and maintaining the enjoyment of the properties and the value thereof;
  - (b) the Association is not empowered, and has not been created, to act as an entity which enforces or ensures the compliance with the laws of the United States, State of Florida, County, City and/or any other jurisdiction or the prevention of tortious activities; and
  - (c) the provisions of the Association Documents setting forth the uses of assessments which relate to health, safety and/or welfare shall be interpreted and applied only as limitations on the uses of assessment funds and not as creating a duty of the Association to protect or further the health, safety or welfare of any person(s), even if assessment funds are chosen to be used for any such reason.

Each Owner (by virtue of his acceptance of title to his Unit) and each other person having an interest in or lien upon, or making use of, any portion of the properties (by virtue of accepting such interest or lien or making such use) shall be bound by this provision and shall be deemed to have automatically waived any and all rights, claims, demands and causes of action against the Association arising from or connected with any matter for which the liability of the Association has been disclaimed hereby. As used herein, "Association" shall include within its meaning all of Association's directors, officers, committee and board members, employees, agents, contractors (including management companies), subcontractors, successors nominees and assigns. The provisions hereof shall also inure to the benefit of Developer, which shall be fully protected hereby.

(Reserved for Clerk of Court)

IN WITNESS WHEREOF, the Developer has caused this Declaration to be duly executed and its corporate seal to be hereunto affixed as of the \_\_\_ day of \_\_\_\_\_, 200\_\_.

Witnessed by:

Monterey Capital Partners, LLC,  
A Florida limited liability company.

*Charles A. Johnson*  
Name: CHARLES A. JOHNSON

By: *Scott Auker*  
Name: SCOTT AUKER  
Title: MANAGER

Name: \_\_\_\_\_

[CORPORATE SEAL]

Address: \_\_\_\_\_  
\_\_\_\_\_

STATE OF FLORIDA )  
COUNTY OF BREVARD ) SS:

The foregoing Declaration was acknowledged before me, this 14 day of FEB, 2006, by SCOTT AUKER, as MANAGER of Monterey Capital Partners, LLC, a Florida limited liability company, on behalf of said company. He/she is personally known to me or has produced FL.DL. as identification.

*Charles A. Johnson*  
Name: \_\_\_\_\_

My Commission Expires:  
\_\_\_\_\_

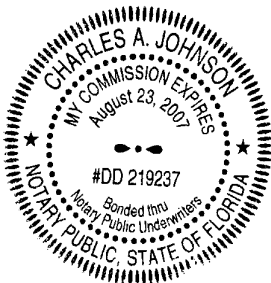

Notary Public, State of Florida  
Commission No.: \_\_\_\_\_

(Notarial Seal)

(Reserved for Clerk of Court)

**JOINDER**

MONTEREY AT BEACH BOULEVARD CONDOMINIUM ASSOCIATION, INC., a Florida corporation not for profit, hereby agrees to accept all the benefits and all of the duties, responsibilities, obligations and burdens imposed upon it by the provisions of this Declaration and Exhibits attached hereto.

IN WITNESS WHEREOF, MONTEREY AT BEACH BOULEVARD CONDOMINIUM ASSOCIATION, INC. has caused these presents to be signed in its name by its proper officer and its corporate seal to be affixed this 14 day of FEB, 2005, 2006

Witnessed by:

MONTEREY AT BEACH BOULEVARD CONDOMINIUM ASSOCIATION, INC., a Florida corporation not for profit

Charles R. Johnson  
Name: CHARLES R. JOHNSON

By: Scott Auker  
SCOTT AUKER, President

Name: \_\_\_\_\_

[CORPORATE SEAL]

STATE OF FLORIDA )  
COUNTY OF BROWARD ) SS:

The foregoing joinder was acknowledged before me this 14 day of FEB, 2006, by SCOTT AUKER, as President of **MONTEREY AT BEACH BOULEVARD CONDOMINIUM ASSOCIATION, INC.**, a Florida corporation not-for-profit, on behalf of said corporation. He is personally known to me or has produced FL. DL. as identification.



Charles A. Johnson  
Name: \_\_\_\_\_

Notary Public, State of Florida

My Commission Expires: \_\_\_\_\_

Commission No.: \_\_\_\_\_

(Notarial Seal)

(Reserved for Clerk of Court)

**CONSENT OF MORTGAGEE**

THIS CONSENT is given as of the 24 day of February, 2006 on behalf of CAPITALSOURCE FINANCE LLC, a Delaware limited liability company ("Mortgagee"), being the owner and holder of that certain mortgage given by MONTEREY CAPITAL PARTNERS, LLC, a Florida limited liability company ("Mortgagor") dated May 19, 2005, and recorded May 23, 2005 in Official Record Book 12500 at Page 2322 of the Public Records of Duval County, Florida (as amended or modified, the "Mortgage.")

WHEREAS, Mortgagor has requested Mortgagee to consent to the recording of the Declaration of MONTEREY AT BEACH BOULEVARD, A CONDOMINIUM (the "Declaration");

NOW THEREFORE, Mortgagee consents to the recordation of the Declaration.

Mortgagee makes no warranty or any representation of any kind or nature concerning the Declaration, any of its provisions, or the legal sufficiency thereof, and disavows any such warranty or representation as well as any participation in the development of MONTEREY AT BEACH BOULEVARD, A CONDOMINIUM (the "Condominium"), and does not assume and shall not be responsible for any of the obligations or liabilities of the developer contained in the Declaration or prospectus, or other documents issued in connection with the promotion of the Condominium. None of the representations contained in the prospectus or other documents shall be deemed to have been made by Mortgagee, nor shall they be construed to create any obligation on Mortgagee to any person relying thereon. This consent is limited to the purposes and requirements of Section 718.104, Florida Statutes, and does not affect or impair the rights and remedies of Mortgagee as set forth in the Mortgage or in the Declaration.

Made as of the day and year first above written.

Witnessed by:

Jackie M. Mathewson  
Name: Jackie M. Mathewson

D. Althouse  
Name: D. Althouse

CAPITALSOURCE FINANCE, LLC

By: Lee T. Smith  
Name: Lee T. Smith  
Title: Senior Counsel  
(Corporate Seal)

Address: \_\_\_\_\_  
\_\_\_\_\_

STATE OF MD

COUNTY OF Montgomery

The foregoing instrument was acknowledged before me this 24 day of February 2006, by Lee T. Smith, as Senior Counsel of CAPITALSOURCE FINANCE, LLC, a Delaware limited liability company on behalf of said company. He/she is personally known to me or has produced \_\_\_\_\_ as identification.

Jackie M. Mathewson  
Name: Jackie M. Mathewson

Notary Public State of: MD  
Commission No.: N/A

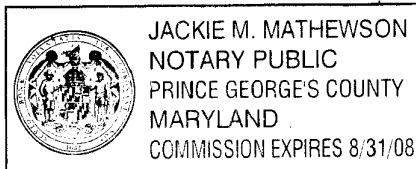
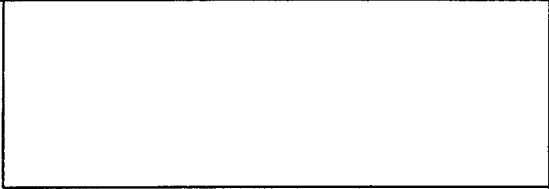

Exhibit 71<sup>n</sup>  
LEGAL DESCRIPTION

A PART OF SECTION 33, TOWNSHIP 2 SOUTH, RANGE 27 EAST, DUVAL COUNTY, FLORIDA, BEING MORE PARTICULARLY DESCRIBED AS FOLLOWS: FOR A POINT OF REFERENCE, COMMENCE AT THE NORTHWEST CORNER OF SAID SECTION 33; THENCE NORTH 88°36'52" EAST ALONG THE NORTH LINE OF SAID SECTION 33, ALSO BEING THE NORTH LINE OF A 60 FOOT DRAINAGE EASEMENT, A DISTANCE OF 1731.66 FEET TO THE NORTHWEST CORNER OF TIMBER RIDGE SUBDIVISION, AS RECORDED IN PLAT BOOK 45, PAGE 50 OF SAID PUBLIC RECORDS; THENCE DEPARTING SAID NORTH LINE SOUTH 00°53'38" EAST ALONG THE WEST LINE OF SAID SUBDIVISION, ALSO BEING THE EAST LINE OF A 50 FOOT DRAINAGE CANAL, A DISTANCE OF 622.69 FEET; THENCE SOUTH 25°49'25" EAST CONTINUING ALONG SAID SUBDIVISION AND EAST LINE, A DISTANCE OF 308.40 FEET; THENCE SOUTH 00°50'48" EAST CONTINUING ALONG SAID SUBDIVISION AND EAST LINE, A DISTANCE OF 500.74 FEET; THENCE SOUTH 22°00'40" EAST CONTINUING ALONG SAID SUBDIVISION AND EAST LINE, A DISTANCE OF 384.09 FEET TO THE POINT OF BEGINNING; THENCE DEPARTING SAID EASTERLY RIGHT-OF-WAY LINE OF SAID CANAL NORTH 89°30'20" EAST ALONG THE SOUTH LINE OF SAID SUBDIVISION, A DISTANCE OF 1031.73 FEET; THENCE SOUTH 00°29'57" EAST ALONG THE WEST LINE OF SAID SUBDIVISION, A DISTANCE OF 826.55 FEET; THENCE DEPARTING SAID LINE SOUTH 89°30'20" WEST, A DISTANCE OF 300.00 FEET; THENCE SOUTH 00°29'40" EAST, A DISTANCE OF 200.00 FEET TO A POINT ON THE NORTHERLY RIGHT-OF-WAY LINE OF BEACH BOULEVARD/U.S. HIGHWAY 90 (A 200 FOOT RIGHT-OF-WAY AS NOW ESTABLISHED); THENCE SOUTH 89°30'20" WEST ALONG SAID RIGHT-OF-WAY LINE, A DISTANCE OF 100.00 FEET TO A POINT ON THE NORTHEASTERLY LINE OF SAID 50 FOOT DRAINAGE CANAL; THENCE NORTH 59°28'52" WEST ALONG SAID NORTHEASTERLY LINE, A DISTANCE OF 583.42 FEET; THENCE NORTH 00°29'40" WEST CONTINUING ALONG SAID NORTHEASTERLY LINE, A DISTANCE OF 384.31 FEET; THENCE NORTH 21°35'12" WEST CONTINUING ALONG SAID LINE, A DISTANCE OF 366.18 FEET TO THE POINT OF BEGINNING.

Exhibit "2"

CONDOMINIUM DRAWINGS  
MONTEREY AT BEACH BOULEVARD,  
A CONDOMINIUM



CONDOMINIUM CERTIFICATION TO MONTEREY AT BEACH BOULEVARD, A CONDOMINIUM

I HEREBY CERTIFY THAT I AM A DULY REGISTERED PROFESSIONAL SURVEYOR AND MAPPER AUTHORIZED TO PRACTICE UNDER THE LAWS OF THE STATE OF FLORIDA, SURVEYOR NO. LS 6016, AND THAT IN ACCORDANCE WITH THE PROVISIONS OF SECTION 718.104(4)(E), FLORIDA STATUTES, THE CONSTRUCTION OF THE IMPROVEMENTS CONSTITUTING MONTEREY AT BEACH BOULEVARD, A CONDOMINIUM, INCLUDING WITHOUT LIMITATION, LANDSCAPING, UTILITY SERVICES, ACCESS TO ALL BUILDINGS AND COMMON ELEMENT FACILITIES SERVING ALL SUCH IMPROVEMENTS, IS SUBSTANTIALLY COMPLETE SO THAT THE MATERIAL, TOGETHER WITH THE PROVISIONS OF THE DECLARATION OF CONDOMINIUM OF MONTEREY AT BEACH BOULEVARD, A CONDOMINIUM TO WHICH THIS CERTIFICATE IS ATTACHED, DESCRIBING THE CONDOMINIUM PROPERTY, IS AN ACCURATE REPRESENTATION OF THE LOCATION AND DIMENSIONS OF ALL IMPROVEMENTS AND FURTHER THAT THE IDENTIFICATION, LOCATION AND DIMENSIONS OF THE COMMON ELEMENTS AND ASSOCIATION PROPERTY AND EACH UNIT CAN BE DETERMINED FROM THESE MATERIALS.

CERTIFICATION TO SURVEY DATA, CONTAINED ON EXHIBITS ATTACHED TO THE DECLARATION FOR MONTEREY AT BEACH BOULEVARD, A CONDOMINIUM.

I HEREBY CERTIFY THAT THE AFOREMENTIONED SURVEY MAP IS A TRUE AND CORRECT REPRESENTATION OF A SURVEY MADE UNDER MY SUPERVISION AND THAT SAID SURVEY MEETS OR EXCEEDS MINIMUM TECHNICAL STANDARDS PURSUANT TO SECTION 472.027, OF THE FLORIDA STATUTES.

*Joseph K. Lek*  
\_\_\_\_\_  
JOSEPH K. LEK  
FLORIDA CERTIFICATE NO. LS 6016  
DATE: AUGUST 26, 2005



Bessent, Hammack & Ruckman, Inc.  
Engineers • Planners • Landscape Architects • Surveyors  
1900 Corporate Square Boulevard  
Jacksonville, Florida 32216  
Phone (904) 721-2991 Fax (904) 725-0171  
Certification Number LB 6739

EXHIBIT 'A'  
SHEET 1 OF 41

**CONDOMINIUM DRAWINGS  
MONTEREY AT BEACH BOULEVARD,  
A CONDOMINIUM**

A PART OF SECTION 33, TOWNSHIP 2 SOUTH, RANGE 27 EAST, DUVAL COUNTY, FLORIDA, BEING MORE PARTICULARLY DESCRIBED AS FOLLOWS: FOR A POINT OF REFERENCE, COMMENCE AT THE NORTHWEST CORNER OF SAID SECTION 33; THENCE NORTH 88°36'52" EAST ALONG THE NORTH LINE OF SAID SECTION 33, ALSO BEING THE NORTH LINE OF A 60 FOOT DRAINAGE EASEMENT, A DISTANCE OF 1731.66 FEET TO THE NORTHWEST CORNER OF TIMBER RIDGE SUBDIVISION, AS RECORDED IN PLAT BOOK 45, PAGE 50 OF SAID PUBLIC RECORDS; THENCE DEPARTING SAID NORTH LINE SOUTH 00°53'38" EAST ALONG THE WEST LINE OF SAID SUBDIVISION, ALSO BEING THE EAST LINE OF A 50 FOOT DRAINAGE CANAL, A DISTANCE OF 622.69 FEET; THENCE SOUTH 25°49'25" EAST CONTINUING ALONG SAID SUBDIVISION AND EAST LINE, A DISTANCE OF 308.40 FEET; THENCE SOUTH 00°50'48" EAST CONTINUING ALONG SAID SUBDIVISION AND EAST LINE, A DISTANCE OF 500.74 FEET; THENCE SOUTH 22°00'40" EAST CONTINUING ALONG SAID SUBDIVISION AND EAST LINE, A DISTANCE OF 384.09 FEET TO THE POINT OF BEGINNING; THENCE DEPARTING SAID EASTERLY RIGHT-OF-WAY LINE OF SAID CANAL NORTH 89°30'20" EAST ALONG THE SOUTH LINE OF SAID SUBDIVISION, A DISTANCE OF 1031.73 FEET; THENCE SOUTH 00°29'57" EAST ALONG THE WEST LINE OF SAID SUBDIVISION, A DISTANCE OF 826.55 FEET; THENCE DEPARTING SAID LINE SOUTH 89°30'20" WEST, A DISTANCE OF 300.00 FEET; THENCE SOUTH 00°29'40" EAST, A DISTANCE OF 200.00 FEET TO A POINT ON THE NORTHERLY RIGHT-OF-WAY LINE OF BEACH BOULEVARD/U.S. HIGHWAY 90 (A 200 FOOT RIGHT-OF-WAY AS NOW ESTABLISHED); THENCE SOUTH 89°30'20" WEST ALONG SAID RIGHT-OF-WAY LINE, A DISTANCE OF 100.00 FEET TO A POINT ON THE NORTHEASTERLY LINE OF SAID 50 FOOT DRAINAGE CANAL; THENCE NORTH 59°28'52" WEST ALONG SAID NORTHEASTERLY LINE, A DISTANCE OF 583.42 FEET; THENCE NORTH 00°29'40" WEST CONTINUING ALONG SAID NORTHEASTERLY LINE, A DISTANCE OF 384.31 FEET; THENCE NORTH 21°35'12" WEST CONTINUING ALONG SAID LINE, A DISTANCE OF 366.18 FEET TO THE POINT OF BEGINNING.

CONTAINING 18.62 ACRES MORE OR LESS.



**Bessent, Hammack & Ruckman, Inc.**  
Engineers • Planners • Landscape Architects • Surveyors  
1900 Corporate Square Boulevard  
Jacksonville, Florida 32216  
Phone (904) 721-2991 Fax (904) 725-0171  
Certification Number LB 6739

**EXHIBIT 'A'**  
SHEET 2 OF 41

JUNE 29, 2005



**CONDOMINIUM DRAWINGS  
MONTEREY AT BEACH BOULEVARD,  
A CONDOMINIUM**

**NOTES:**

1. BEARINGS SHOWN HEREON BASED ON STATE PLANE COORDINATES, FLORIDA EAST ZONE, WITH A BEARING OF NORTH 88°50'20" EAST ON THE NORTH LINE OF SECTION 33, AS SHOWN HEREON.
2. THIS PROPERTY APPEARS TO LIE IN FLOOD ZONE UNSHADED "X" WHICH IS AN AREA DETERMINED TO BE OUTSIDE THE 500-YEAR FLOOD PLAIN, ACCORDING TO COMMUNITY-PANEL NO. 120077-0237-E OF THE FLOOD INSURANCE RATE MAPS FOR DUVAL COUNTY, FLORIDA, DATED AUGUST 15, 1989.
3. THE ZONING DESIGNATION FOR THE ABOVE DESCRIBED PROPERTY IS RESIDENTIAL MEDIUM DENSITY-E (RMD-E). RMD-E HAS SETBACKS OF 25 FEET FRONT, 10 FEET SIDE, AND 10 FEET REAR PER SECTION 656.306 OF THE ORDINANCE CODE FOR THE CITY OF JACKSONVILLE.
4. THIS SURVEY WAS PERFORMED WITH THE BENEFIT OF FIRST AMERICAN TITLE INSURANCE COMPANY FATIC NO. AA-6953, WITH AN EFFECTIVE DATE OF JUNE 7, 2002.
5. THE ABOVE DESCRIBED LANDS BEING SUBJECT TO THAT BLANKET JEA EASEMENT AS RECORDED IN BOOK 6003, PAGE 829 OF THE CURRENT PUBLIC RECORDS OF DUVAL COUNTY, FLORIDA.
6. THE ABOVE DESCRIBED LANDS BEING SUBJECT TO THAT JEA EASEMENT AS RECORDED IN BOOK 6004, PAGE 1473, OF THE CURRENT PUBLIC RECORDS OF DUVAL COUNTY, FLORIDA, AS SHOWN HEREON.
7. THE ABOVE DESCRIBED LANDS BEING SUBJECT TO A BLANKET EASEMENT GRANTED TO MEDIAONE OF GREATER FLORIDA, INC. AS RECORDED OCTOBER 11, 2000, IN BOOK 9768, PAGE 317 (AS TO PARCEL A), OF THE CURRENT PUBLIC RECORDS OF DUVAL COUNTY, FLORIDA.
8. THERE ARE NO GAPS OR GORES BETWEEN THOSE LANDS DESCRIBED HEREON AND THE LANDS OWNED BY ROLLING OAKS APARTMENTS, LYING NORTHERLY OF AND ADJACENT TO THE SUBJECT PROPERTY.
9. ONLY ABOVE GROUND INDICATORS TO BELOW GROUND UTILITIES WERE LOCATED BY THIS SURVEY. OTHER UTILITIES MAY BE PRESENT AND NOT SHOWN HEREON.
10. THIS SURVEY WAS PERFORMED WITH THE BENEFIT OF FIRST AMERICAN TITLE INSURANCE COMPANY FATIC NO. 217P, WITH AN EFFECTIVE DATE OF OCTOBER 25, 2004.

**TITLE EXCEPTIONS:**

8. THE ABOVE DESCRIBED LANDS BEING SUBJECT TO THAT BLANKET JEA EASEMENT AS RECORDED IN OFFICIAL RECORDS BOOK 6003, PAGE 829 OF THE CURRENT PUBLIC RECORDS OF DUVAL COUNTY, FLORIDA, AS SHOWN HEREON (PHASE I).
9. THE ABOVE DESCRIBED LANDS BEING SUBJECT TO THAT JEA EASEMENT AS RECORDED IN BOOK 6004, PAGE 1473, OF THE CURRENT PUBLIC RECORDS OF DUVAL COUNTY, FLORIDA, AS SHOWN HEREON (PHASE I).
10. THE ABOVE DESCRIBED LANDS BEING SUBJECT TO A BLANKET EASEMENT GRANTED TO MEDIAONE OF GREATER FLORIDA, INC. AS RECORDED OCTOBER 11, 2000, IN BOOK 9768, PAGE 317, OF THE CURRENT PUBLIC RECORDS OF DUVAL COUNTY, FLORIDA.
11. THE ABOVE DESCRIBED LANDS BEING SUBJECT TO A CONSERVATION EASEMENT RECORDED IN OFFICIAL RECORDS BOOK 11763, PAGE 2200 OF THE CURRENT PUBLIC RECORDS OF DUVAL COUNTY, FLORIDA, AS SHOWN HEREON (PHASE II).
13. THE ABOVE DESCRIBED LANDS MAY BE SUBJECT TO THAT EASEMENT GRANTED TO JACKSONVILLE ELECTRIC AUTHORITY BY INSTRUMENT RECORDED IN "UNRECORDED" CONSENT AND JOINDER IN BOOK 11146, PAGE 2402. EASEMENT NOT SHOWN HEREON DUE TO LACK OF LEGAL DESCRIPTION IN SAID DOCUMENT.
11. ALL AREA AND IMPROVEMENTS WHICH ARE BEING DEDICATED TO THE CONDOMINIUM EXCLUSIVE OF THE UNITS AND LIMITED COMMON ELEMENTS ARE COMMON ELEMENTS.
12. UNIT BOUNDARIES. EACH UNIT SHALL INCLUDE THAT PART OF THE BUILDING CONTAINING THE UNIT THAT LIES WITHIN THE FOLLOWING BOUNDARIES:
  - a. UPPER AND LOWER BOUNDARIES - THE UPPER AND LOWER BOUNDARIES OF THE UNIT SHALL BE THE FOLLOWING BOUNDARIES EXTENDED TO THEIR PLANAR INTERSECTIONS WITH THE PERIMETRICAL BOUNDARIES:
    - i. UPPER BOUNDARIES - THE HORIZONTAL PLANE OF THE UNFINISHED LOWER SURFACE OF THE CEILING (WHICH WILL BE DEEMED TO BE THE CEILING OF THE UPPER STORY IF THE UNIT IS A MULTI-STORY UNIT, PROVIDED THAT IN MULTI-STORY UNITS WHERE THE LOWER BOUNDARY EXTENDS BEYOND THE UPPER BOUNDARY, THE UPPER BOUNDARY SHALL INCLUDE THAT PORTION OF THE CEILING OF THE LOWER FLOOR FOR WHICH THERE IS NO CORRESPONDING CEILING ON THE UPPER FLOOR DIRECTLY ABOVE SUCH BOTTOM FLOOR CEILING).
    - ii. LOWER BOUNDARIES - THE HORIZONTAL PLANE OF THE UNFINISHED UPPER SURFACE OF THE FLOOR OF THE UNIT (WHICH WILL BE DEEMED TO BE THE FLOOR OF THE FIRST STORY IF THE UNIT IS A MULTI-STORY UNIT, PROVIDED THAT IN MULTI-STORY UNITS WHERE THE UPPER BOUNDARY EXTENDS BEYOND THE LOWER BOUNDARY, THE LOWER BOUNDARY SHALL INCLUDE THAT PORTION OF THE CEILING OF THE UPPER FLOOR FOR WHICH THERE IS NO CORRESPONDING CEILING ON THE BOTTOM FLOOR DIRECTLY BELOW THE FLOOR OF SUCH TOP FLOOR).
    - iii. INTERIOR DIVISIONS - EXCEPT AS PROVIDED IN I & II ABOVE, NO PART OF THE FLOOR OF THE TOP FLOOR, CEILING OF THE BOTTOM FLOOR, STAIRWELL ADJOINING THE MULTI-FLOORS, IN ALL CASES OF A MULTI-STORY UNIT, IF ANY, OR NONSTRUCTURAL INTERIOR WALLS SHALL BE CONSIDERED A BOUNDARY OF THE UNIT.
  - b. PERIMETRICAL BOUNDARIES - THE PERIMETRICAL BOUNDARIES OF THE UNIT SHALL BE THE VERTICAL PLANES OF THE UNFINISHED INTERIOR SURFACES OF THE WALLS BOUNDING THE UNIT EXTENDED TO THEIR PLANAR INTERSECTIONS WITH EACH OTHER AND WITH THE UPPER AND LOWER BOUNDARIES.
  - c. APERTURES - WHERE THERE ARE APERTURES IN ANY BOUNDARY, INCLUDING, BUT NOT LIMITED TO, DOORS AND SKYLIGHTS, SUCH BOUNDARIES SHALL BE EXTENDED TO INCLUDE THE DOORS AND OTHER FIXTURES LOCATED IN SUCH APERTURES, EXCLUDING WINDOWS, BUT INCLUDING ALL FRAMEWORKS, WINDOW CASINGS AND WEATHER STRIPPING THEREOF, TOGETHER WITH EXTERIOR SURFACES MADE OF GLASS OR OTHER TRANSPARENT MATERIALS; PROVIDED, HOWEVER, THAT THE EXTERIORS OF DOORS FACING INTERIOR COMMON ELEMENT HALLWAYS SHALL NOT BE INCLUDED IN THE BOUNDARIES OF THE UNIT AND SHALL THEREOF BE COMMON ELEMENTS. NOTWITHSTANDING ANYTHING HEREIN CONTAINED TO THE CONTRARY, ANY ELEVATORS (INCLUDING ALL MECHANICAL EQUIPMENT SERVING, AND HOUSING FOR THE ELEVATORS) SOLELY SERVING A UNIT (TO THE EXCLUSION OF ALL OTHER UNITS) SHALL BE DEEMED PART OF THE UNIT. FURTHER, NOTWITHSTANDING ANYTHING TO THE CONTRARY, THE STRUCTURAL COMPONENTS OF THE BUILDINGS ARE EXPRESSLY EXCLUDED FROM THE UNITS AND ARE INSTEAD DEEMED COMMON ELEMENTS. LASTLY, NOTWITHSTANDING ANYTHING TO THE CONTRARY, THE STRUCTURAL COMPONENTS OF THE BUILDING AND THE LIFE SAFETY SYSTEMS, REGARDLESS WHERE LOCATED, ARE EXPRESSLY EXCLUDED FROM THE UNITS AND ARE INSTEAD DEEMED COMMON ELEMENTS.



**Bessent, Hammack & Ruckman, Inc.**  
 Engineers • Planners • Landscape Architects • Surveyors  
 1900 Corporate Square Boulevard  
 Jacksonville, Florida 32216  
 Phone (904) 721-2591 Fax (904) 725-0171  
 Certification Number LB 6739

**EXHIBIT 'A'**  
 SHEET 3 OF 41

AUGUST 26, 2005

# CONDOMINIUM DRAWINGS MONTEREY AT BEACH BOULEVARD, A CONDOMINIUM SITE SURVEY

(SEE EXHIBIT A, SHEETS 2 & 3 FOR LEGAL  
DESCRIPTION AND NOTES)  
FOR BOUNDARY SURVEY SEE MAP NO. G-162A  
DATED APRIL 13, 2005 PREPARED BY THIS FIRM.

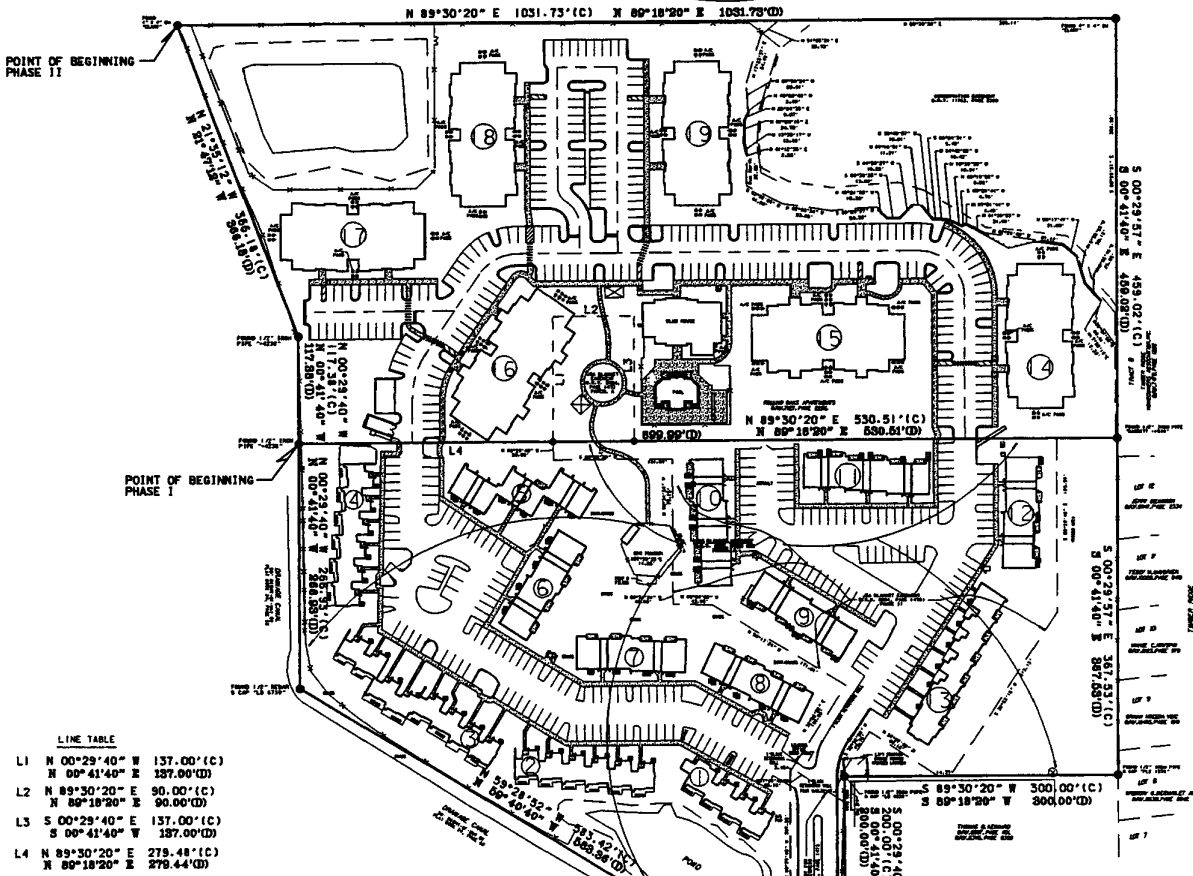

LINE TABLE

|    |               |            |
|----|---------------|------------|
| L1 | N 00°29'40" W | 137.00'(C) |
|    | N 00°41'40" E | 137.00'(C) |
| L2 | N 89°30'20" E | 90.00'(C)  |
|    | N 89°18'20" E | 90.00'(C)  |
| L3 | S 00°29'40" E | 137.00'(C) |
|    | S 00°41'40" W | 137.00'(C) |
| L4 | N 89°30'20" E | 279.48'(C) |
|    | N 89°18'20" E | 279.44'(C) |

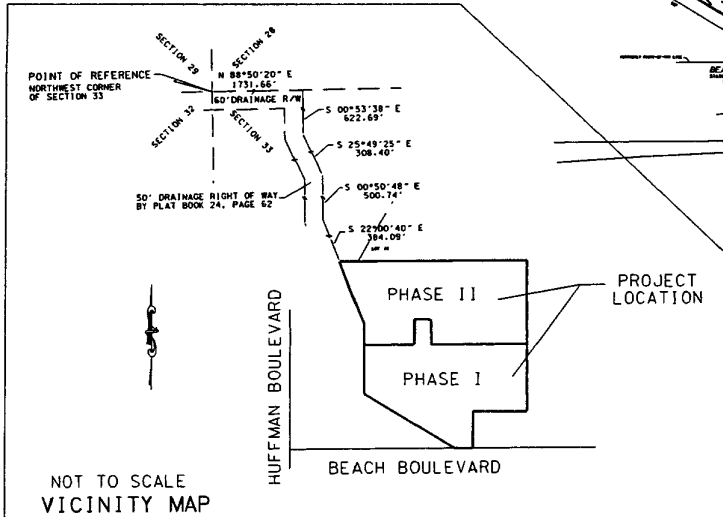

NOT TO SCALE  
VICINITY MAP

**Bessent, Hammack & Ruckman, Inc.**  
Engineers • Planners • Landscape Architects • Surveyors  
1900 Corporate Square Boulevard  
Jacksonville, Florida 32216  
Phone (904) 721-2991 Fax (904) 725-0171  
Certification Number LB 6739

**EXHIBIT 'A'**  
SHEET 4 OF 41

SCALE 1" = 200'  
JUNE 29, 2005

# CONDOMINIUM DRAWINGS MONTEREY AT BEACH BOULEVARD, A CONDOMINIUM

FOUND  
4" X 4" CM  
"CLARY"

A/C  
PADS

A/C  
PADS

A/  
PA

A/C  
PADS

A/C  
PADS

A/C  
PADS

A/C  
PADS

FOUND 1/2" IRON  
PIPE "4238"

A/C  
PADS

FOUND 1/2" IRON  
PIPE "4238"

A/C  
PADS

N 00°2'  
20.



Bessent, Hammack & Ruckman, Inc.  
Engineers • Planners • Landscape Architects • Surveyors  
1900 Corporate Square Boulevard  
Jacksonville, Florida 32216  
Phone (904) 721-2991 Fax (904) 725-0171  
Certification Number LB 6739

EXHIBIT 'A'  
SHEET 5 OF 41

SCALE 1" = 60'  
JUN 29, 2005

CONDOMINIUM DRAWINGS  
 MONTEREY AT BEACH BOULEVARD,  
 A CONDOMINIUM

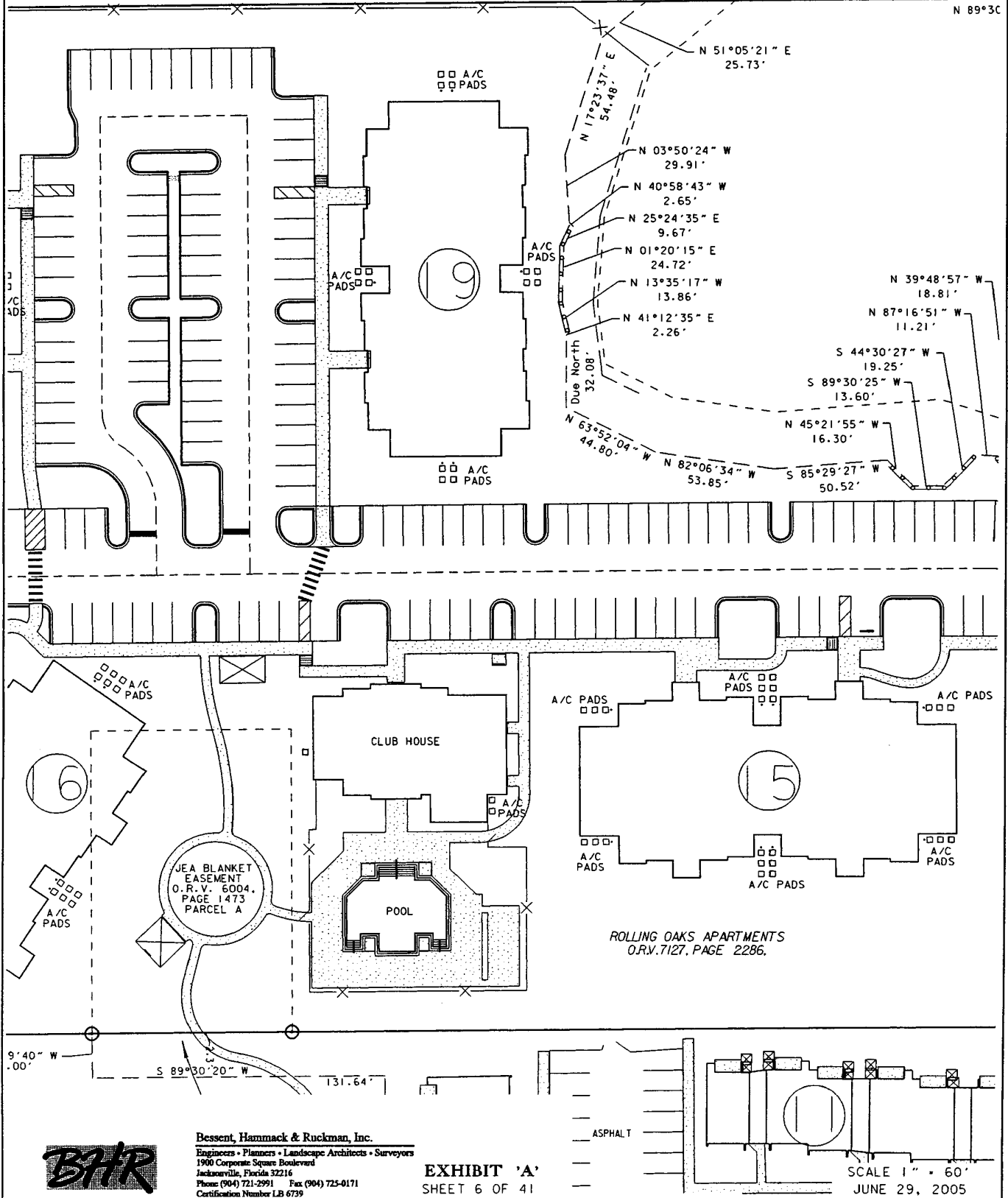

# CONDOMINIUM DRAWINGS MONTEREY AT BEACH BOULEVARD, A CONDOMINIUM

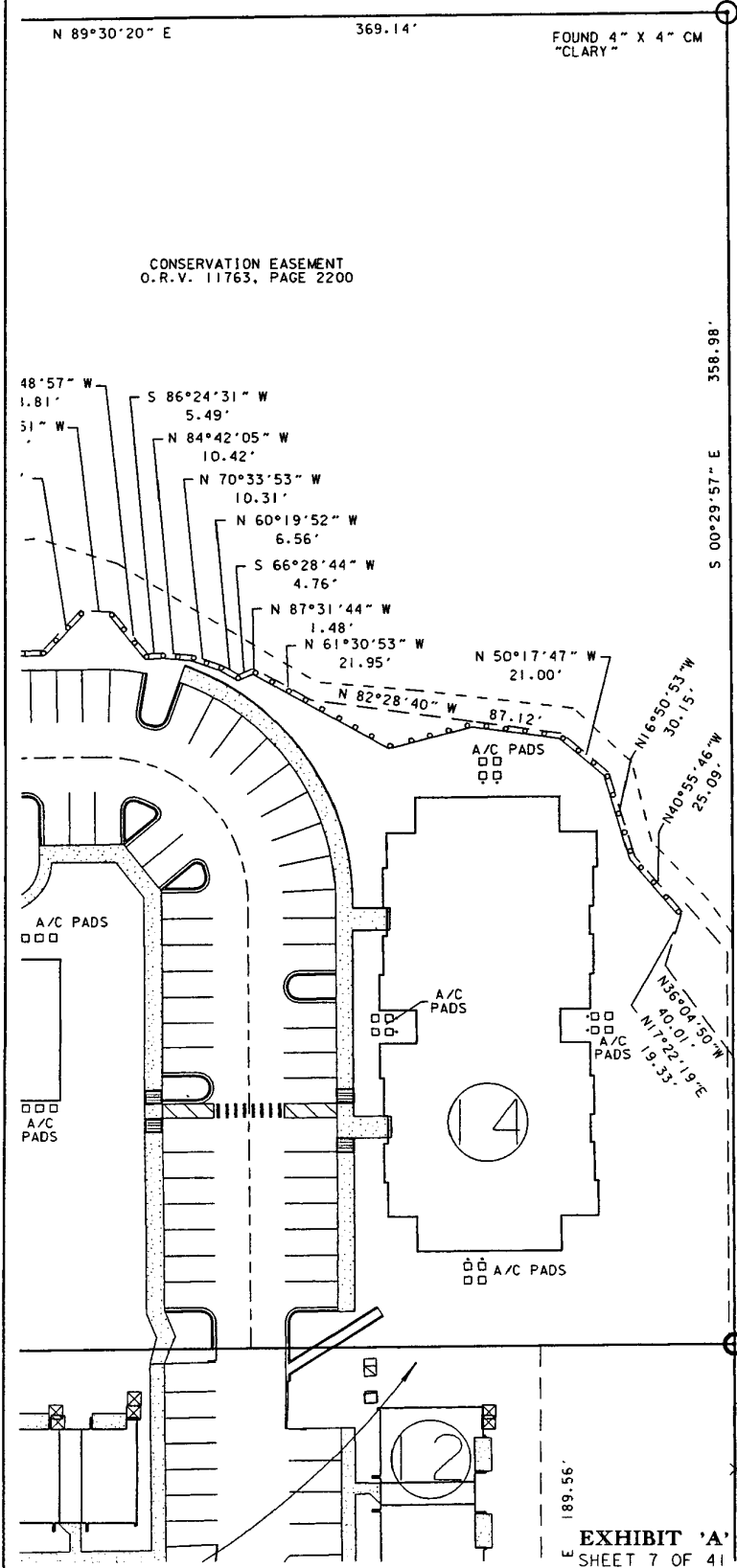

TRACT B  
TIMBER RIDGE  
HOMEOWNERS ASSOCIATION, INC.  
O.R.V. 7478, PAGE 1208

FOUND 1/2" IRON PIPE  
"BASSETT" 1576"



**Bessent, Hammack & Ruckman, Inc.**  
Engineers • Planners • Landscape Architects • Surveyors  
1900 Corporate Square Boulevard  
Jacksonville, Florida 32216  
Phone (904) 721-2991 Fax (904) 725-0171  
Certification Number LB 6739

LOT 12

EXHIBIT 'A'  
SHEET 7 OF 41

JERRY DENNISON  
O.P.V. 9247 PAGE 2334

SCALE 1" = 60'  
JUNE 29, 2005

# CONDOMINIUM DRAWINGS MONTEREY AT BEACH BOULEVARD, A CONDOMINIUM

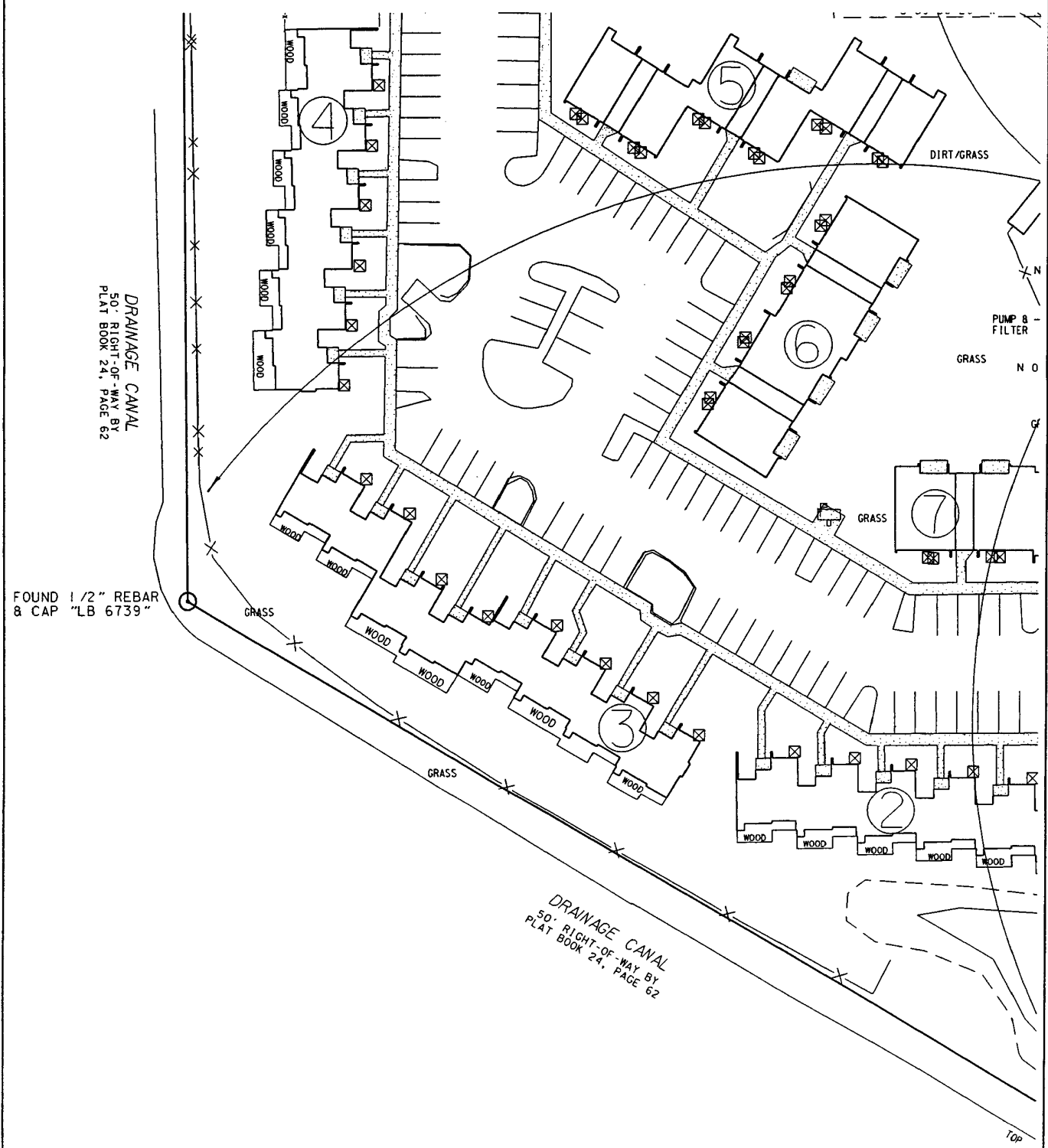

DRAINAGE CANAL  
50' RIGHT-OF-WAY BY  
PLAT BOOK 24, PAGE 62

FOUND 1/2" REBAR  
& CAP "LB 6739"

DRAINAGE CANAL  
50' RIGHT-OF-WAY BY  
PLAT BOOK 24, PAGE 62



**Bessent, Hammack & Ruckman, Inc.**  
Engineers • Planners • Landscape Architects • Surveyors  
1900 Corporate Square Boulevard  
Jacksonville, Florida 32216  
Phone (904) 721-2991 Fax (904) 725-0171  
Certification Number LB 6739

**EXHIBIT 'A'**  
SHEET 8 OF 41

SCALE 1" = 60'  
JUNE 29, 2005

**CONDOMINIUM  
DRAWINGS  
MONTEREY AT  
BEACH BOULEVARD,  
A CONDOMINIUM**

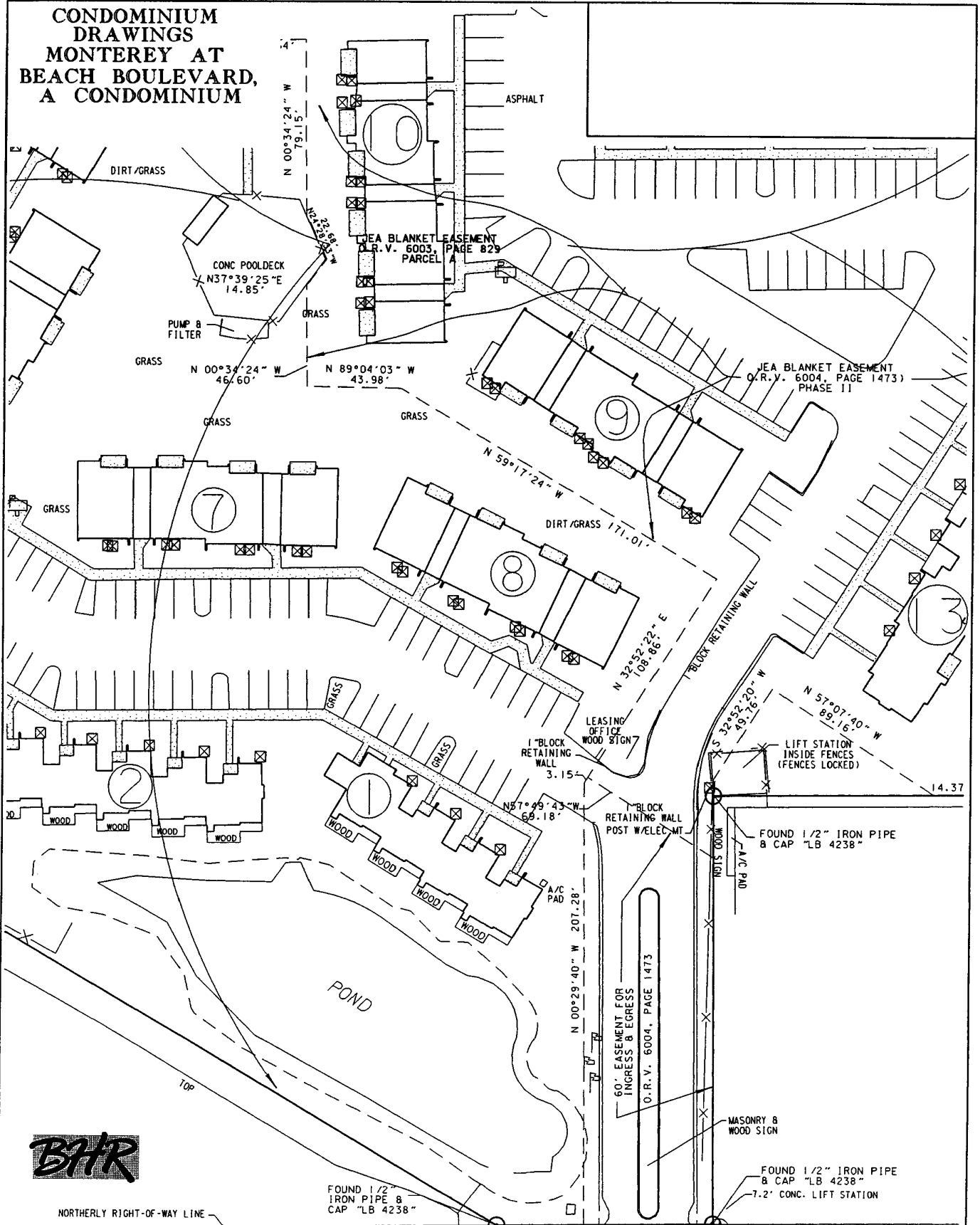

NORTHERLY RIGHT-OF-WAY LINE

**Bessent, Hammack & Ruckman, Inc.**  
Engineers • Planners • Landscape Architects • Surveyors  
1900 Corporate Square Boulevard  
Jacksonville, Florida 32216  
Phone: (904) 721-2991 Fax: (904) 725-0171  
Certification Number LB 6739

**BEACH BOULEVARD**  
STATE ROAD NO. 212/U.S. 90  
(200' RIGHT-OF-WAY)

**EXHIBIT 'A'**  
SHEET 9 OF 41

SCALE 1" = 60'  
JUNE 29, 2005

**CONDOMINIUM DRAWINGS  
MONTEREY AT BEACH BOULEVARD,  
A CONDOMINIUM**

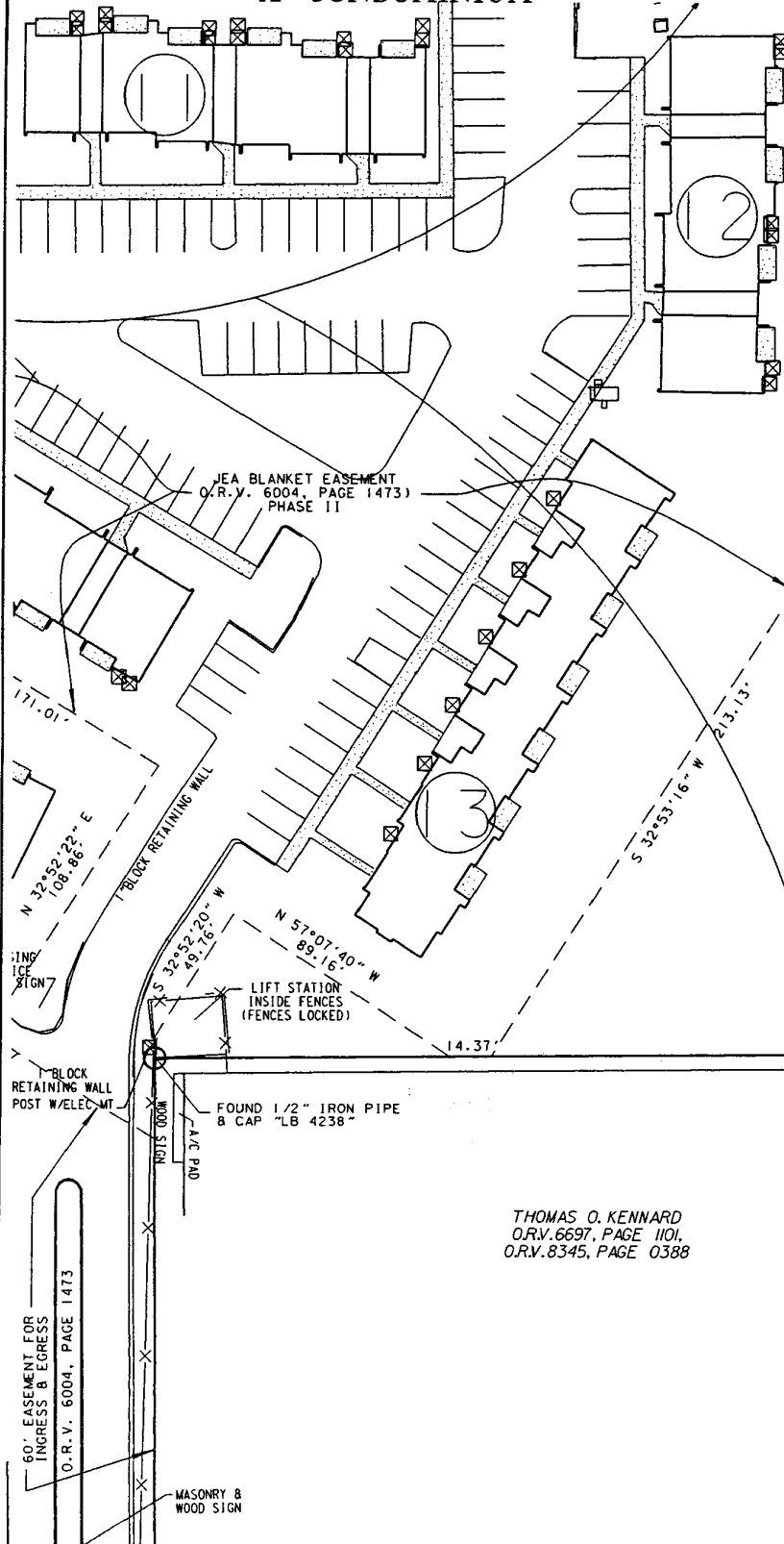

LOT 12  
JERRY DENNISON  
O.R.V. 9047, PAGE 2334

LOT 11  
TEDDY W. MAYBRIER  
O.R.V. 10025, PAGE 0418

LOT 10  
WAYNE C. KRYSPIK  
O.R.V. 8193, PAGE 970

LOT 9  
ORHAN HADZIA VDIC  
O.R.V. 10405, PAGE 1041

FOUND 1/2" IRON PIPE  
& CAP "PLS 1576"  
LOT 8  
GREGORY G. BEEMAN, ET AL.  
O.R.V. 8638, PAGE 0942

LOT 7

TIMBER RIDGE  
(PLAT BOOK 45, PAGES 50-50F)

THOMAS O. KENNARD  
O.R.V. 6697, PAGE 1101,  
O.R.V. 8345, PAGE 0388



**Bessent, Hammack & Ruckman, Inc.**  
Engineers • Planners • Landscape Architects • Surveyors  
1900 Corporate Square Boulevard  
Jacksonville, Florida 32216  
Phone (904) 721-2991 Fax (904) 725-0171  
Certification Number LB 6729

**EXHIBIT 'A'**  
SHEET 10 OF 41

SCALE 1" = 60'  
JUNE 29, 2005



**CONDOMINIUM DRAWINGS  
MONTEREY AT BEACH BOULEVARD,  
A CONDOMINIUM  
UNIT NUMBERS**

**BUILDING 1**

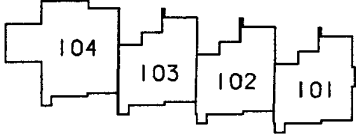

**BUILDING 2**

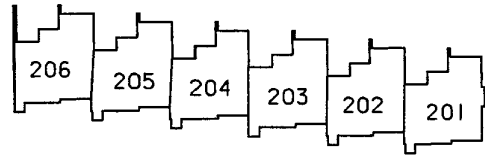

**BUILDING 3**

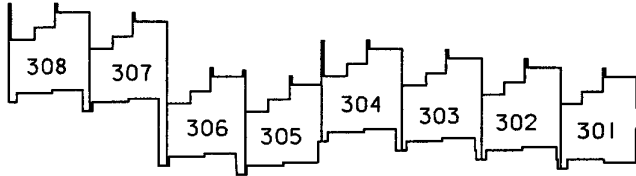

**BUILDING 4**

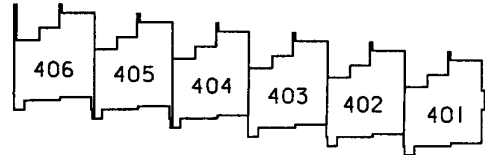

**BUILDING 5**

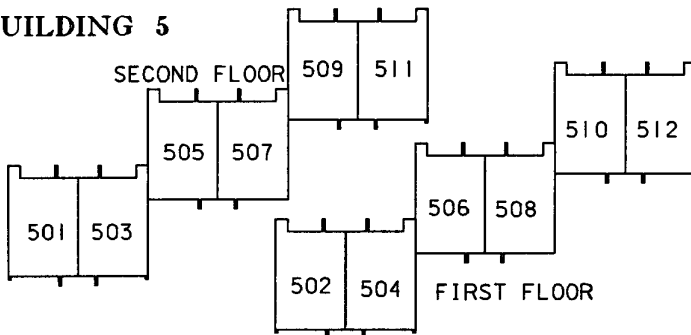

**BUILDING 6**

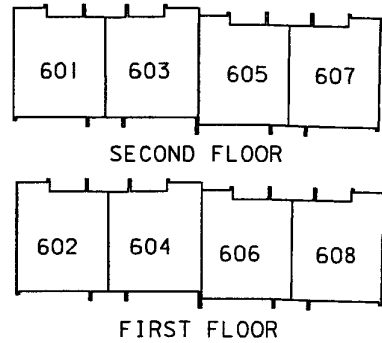

**BUILDING 7**

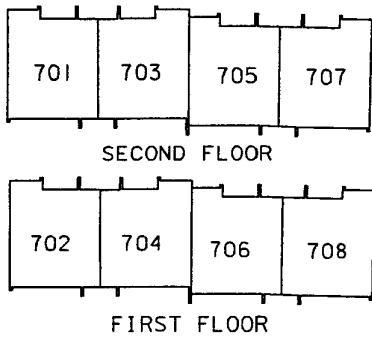

**BUILDING 8**

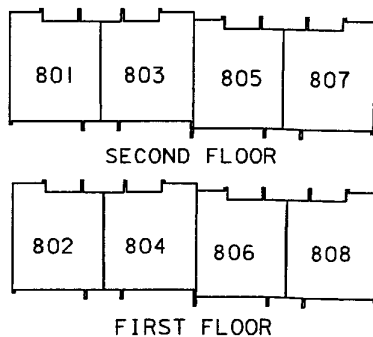

**BUILDING 9**

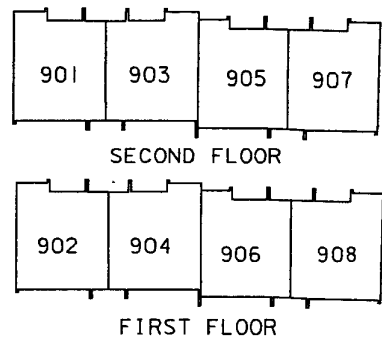

**BUILDING 10**

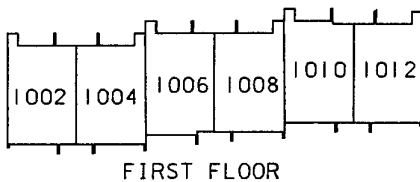

**BUILDING 11**

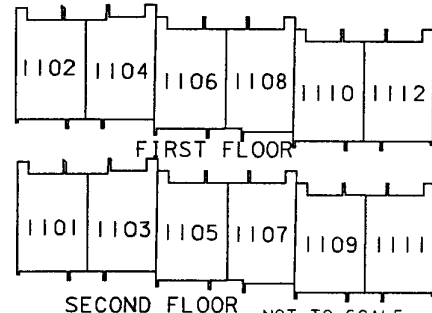
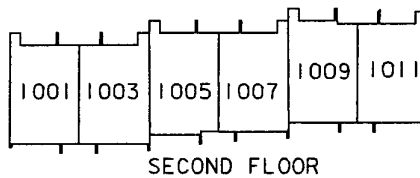

**Bessent, Hammack & Ruckman, Inc.**  
Engineers • Planners • Landscape Architects • Surveyors  
1900 Corporate Square Boulevard  
Jacksonville, Florida 32216  
Phone (904) 721-2991 Fax (904) 725-8171  
Certification Number LB 6739

**EXHIBIT 'A'**  
SHEET 11 OF 41

NOT TO SCALE  
JUNE 29, 2005

**CONDOMINIUM DRAWINGS  
MONTEREY AT BEACH BOULEVARD,  
A CONDOMINIUM  
BUILDING 12 UNIT NUMBERS**

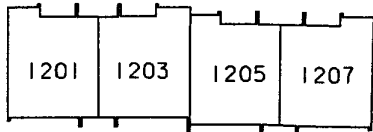

SECOND FLOOR

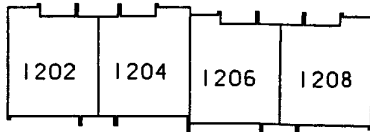

FIRST FLOOR

**BUILDING 13**

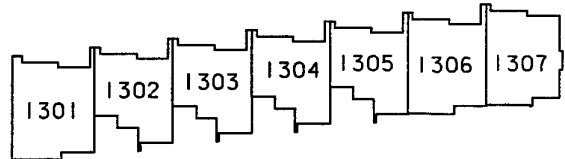

**BUILDING 15**

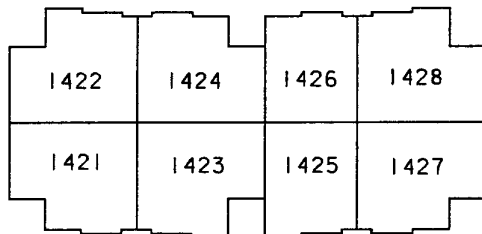

SECOND FLOOR

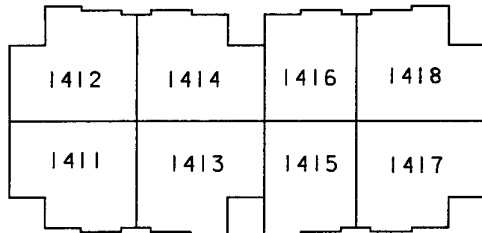

FIRST FLOOR

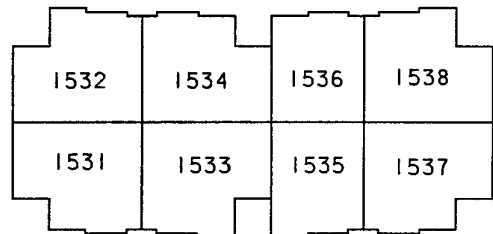

THIRD FLOOR

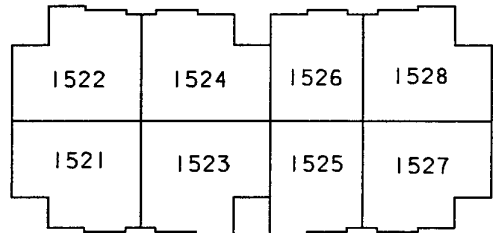

SECOND FLOOR

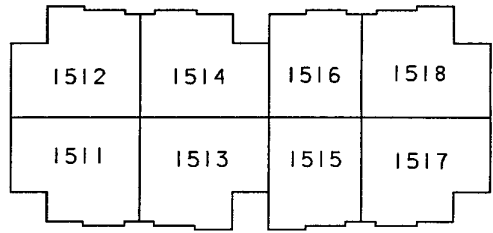

FIRST FLOOR



**Bessent, Hammack & Ruckman, Inc.**  
Engineers • Planners • Landscape Architects • Surveyors  
1900 Corporate Square Boulevard  
Jacksonville, Florida 32216  
Phone (904) 721-2591 Fax (904) 725-0171  
Certification Number LB 6739

**EXHIBIT 'A'**  
SHEET 12 OF 41

NOT TO SCALE  
JUNE 29, 2005

**CONDOMINIUM DRAWINGS  
MONTEREY AT BEACH BOULEVARD,  
A CONDOMINIUM  
UNIT NUMBERS**

**BUILDING 16**

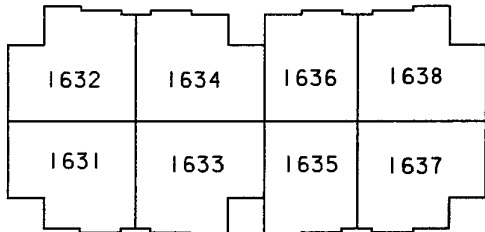

THIRD FLOOR

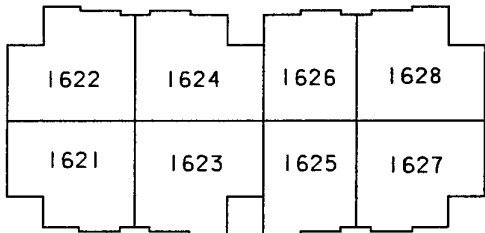

SECOND FLOOR

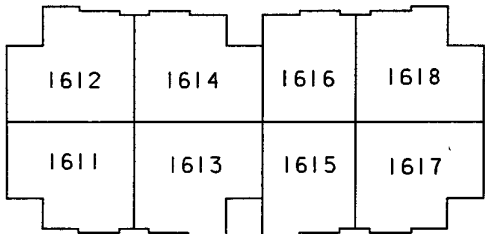

FIRST FLOOR

**BUILDING 18**

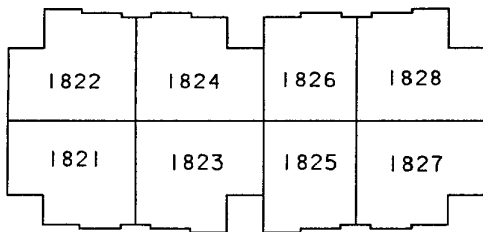

SECOND FLOOR

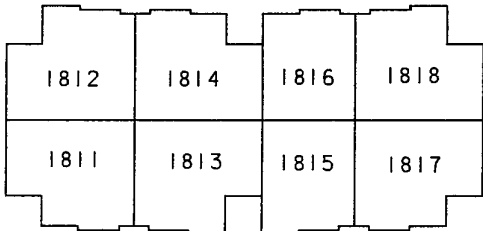

FIRST FLOOR

**BUILDING 17**

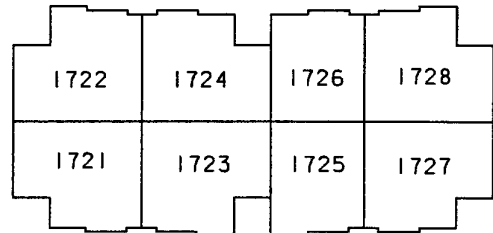

SECOND FLOOR

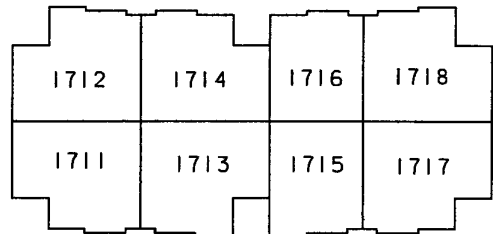

FIRST FLOOR

**BUILDING 19**

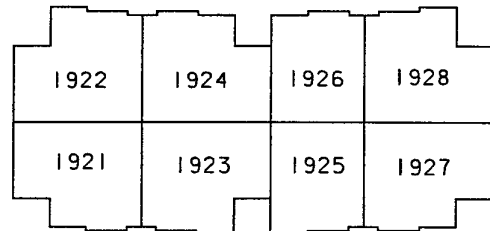

SECOND FLOOR

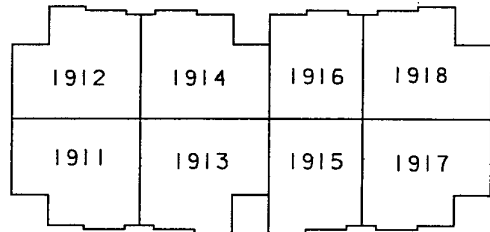

FIRST FLOOR



**Bessent, Hammack & Ruckman, Inc.**  
 Engineers • Planners • Landscape Architects • Surveyors  
 1900 Corporate Square Boulevard  
 Jacksonville, Florida 32216  
 Phone (904) 721-2991 Fax (904) 725-0171  
 Certification Number LB 6739

**EXHIBIT 'A'**  
 SHEET 13 OF 41

NOT TO SCALE  
 JUNE 29, 2005

CONDOMINIUM DRAWINGS  
 MONTEREY AT BEACH BOULEVARD,  
 A CONDOMINIUM  
 FLOOR PLAN

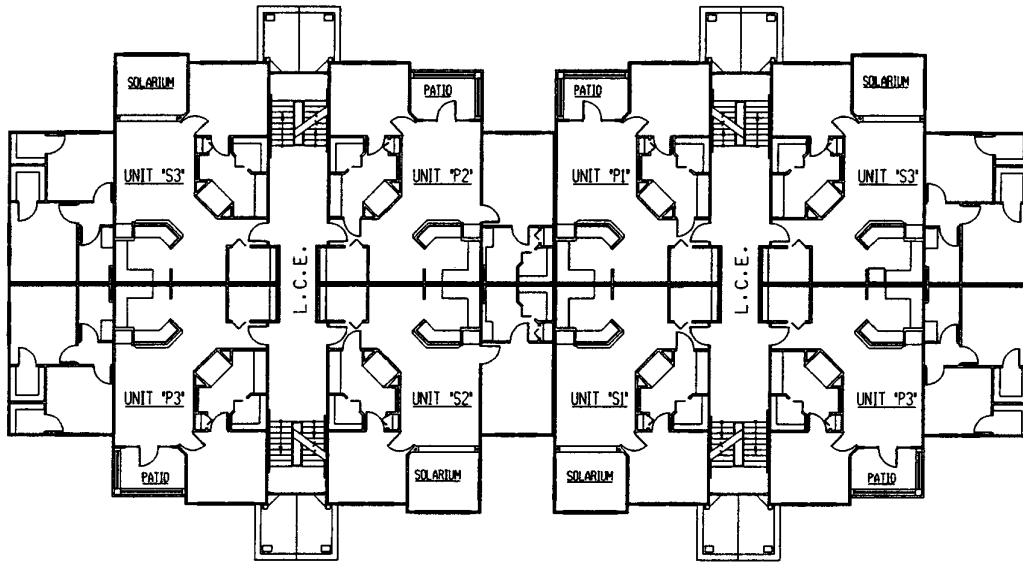

① BUILDING TYPE I SECOND FLOOR PLAN

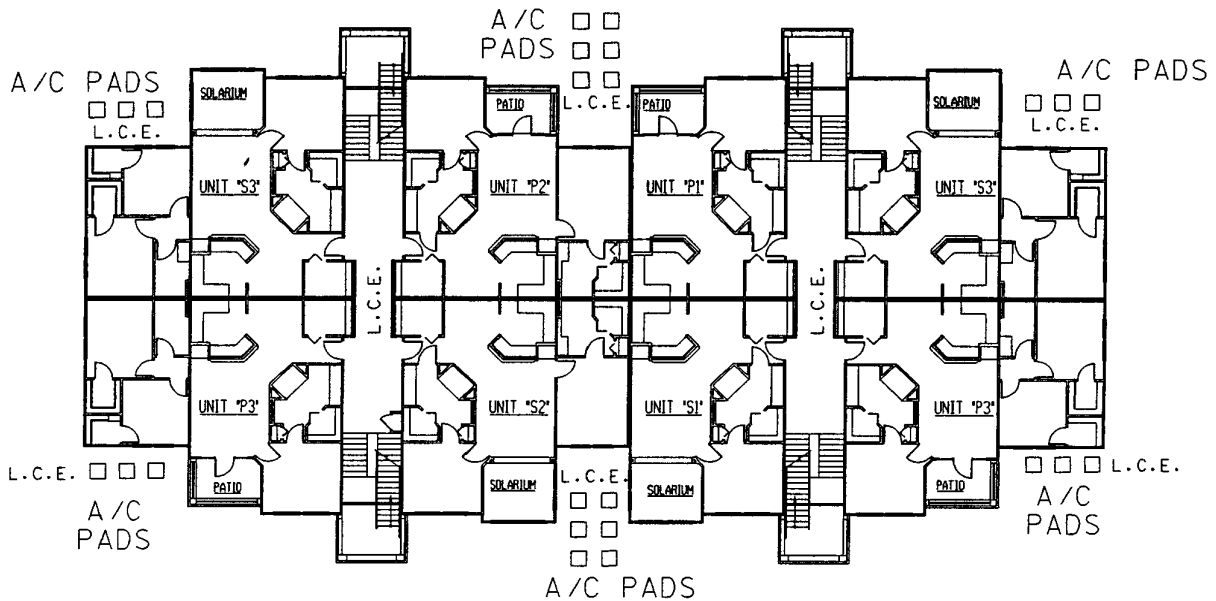

① BUILDING TYPE I - FIRST FLOOR PLAN

BUILDING TYPE I BUILDINGS 15, 16.

LEGEND:  
 L.C.E. DENOTES LIMITED COMMON ELEMENT



Bessent, Hammack & Ruckman, Inc.  
 Engineers - Planners - Landscape Architects - Surveyors  
 1900 Corporate Square Boulevard  
 Jacksonville, Florida 32216  
 Phone (904) 721-2991 Fax (904) 725-0171  
 Certification Number LB 6739

EXHIBIT 'A'  
 SHEET 14 OF 41

JUNE 29, 2005  
 SCALE 1" = 30'

**CONDOMINIUM DRAWINGS  
MONTEREY AT BEACH BOULEVARD,  
A CONDOMINIUM  
FLOOR PLAN**

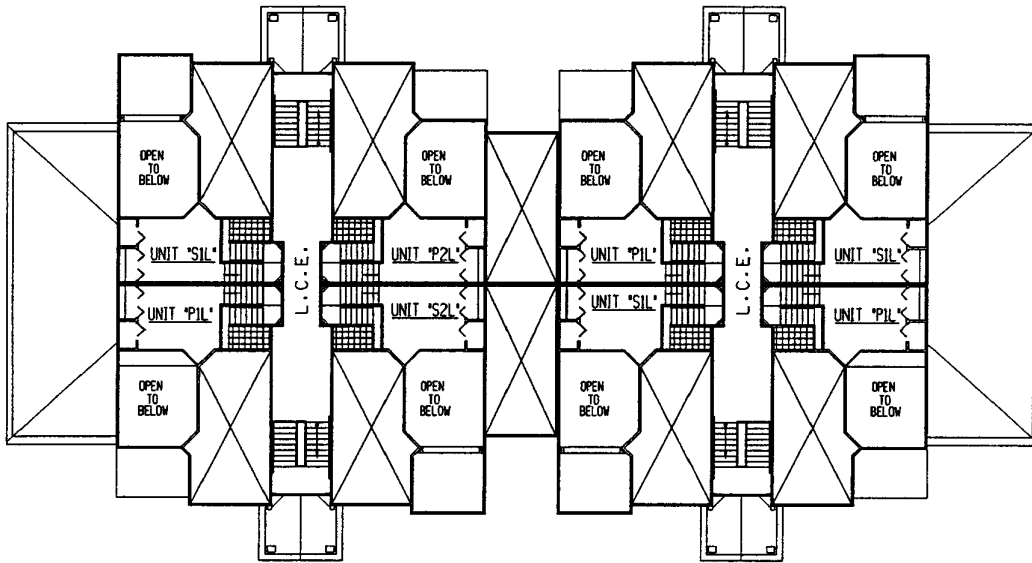

1 BUILDING TYPE I FOURTH FLOOR PLAN

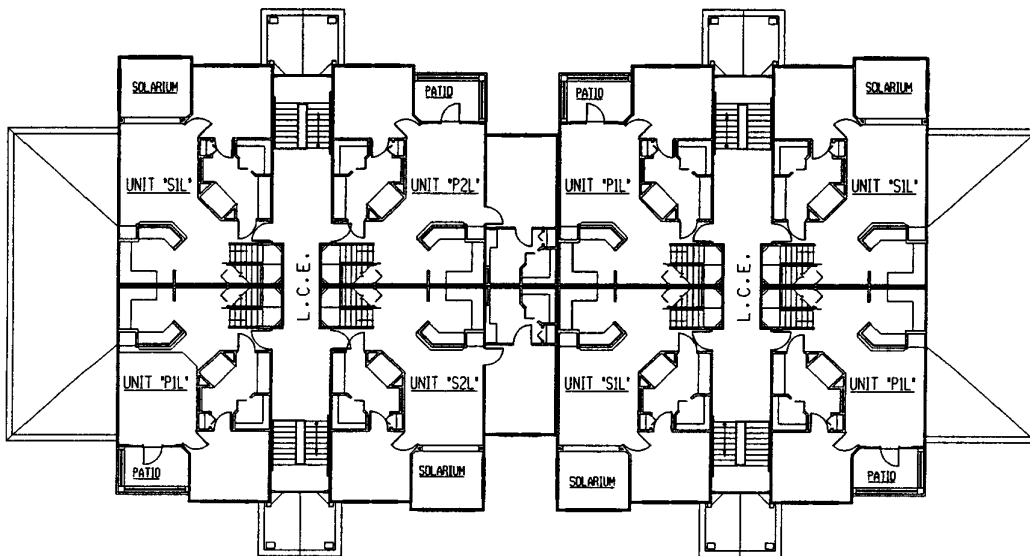

1 BUILDING TYPE I - THIRD FLOOR PLAN

LEGEND:  
L.C.E. DENOTES LIMITED COMMON ELEMENT



**Bessent, Hammack & Ruckman, Inc.**  
Engineers - Planners - Landscape Architects - Surveyors  
1900 Corporate Square Boulevard  
Jacksonville, Florida 32216  
Phone (904) 721-2991 Fax (904) 725-0171  
Certification Number LB 6739

**EXHIBIT 'A'**  
SHEET 15 OF 41

JUNE 29, 2005  
SCALE 1" = 30'

CONDOMINIUM DRAWINGS  
 MONTEREY AT BEACH BOULEVARD,  
 A CONDOMINIUM  
 FLOOR PLAN

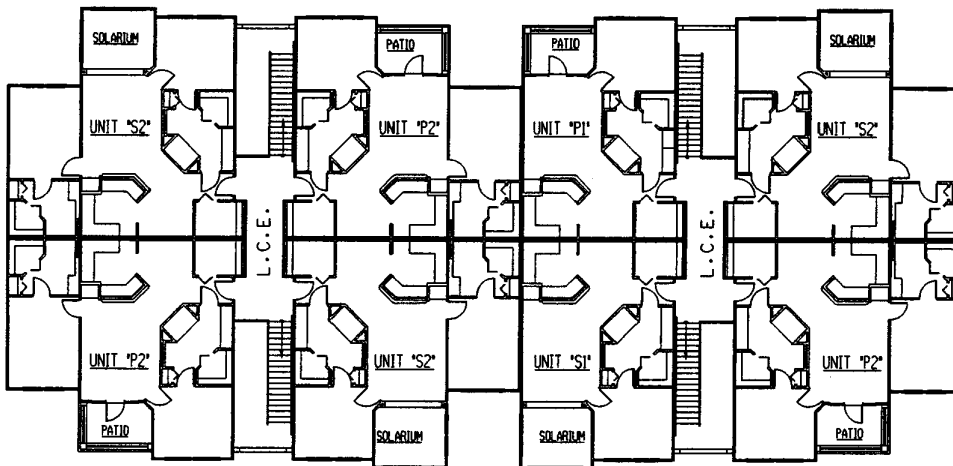

II BUILDING TYPE II SECOND FLOOR PLAN

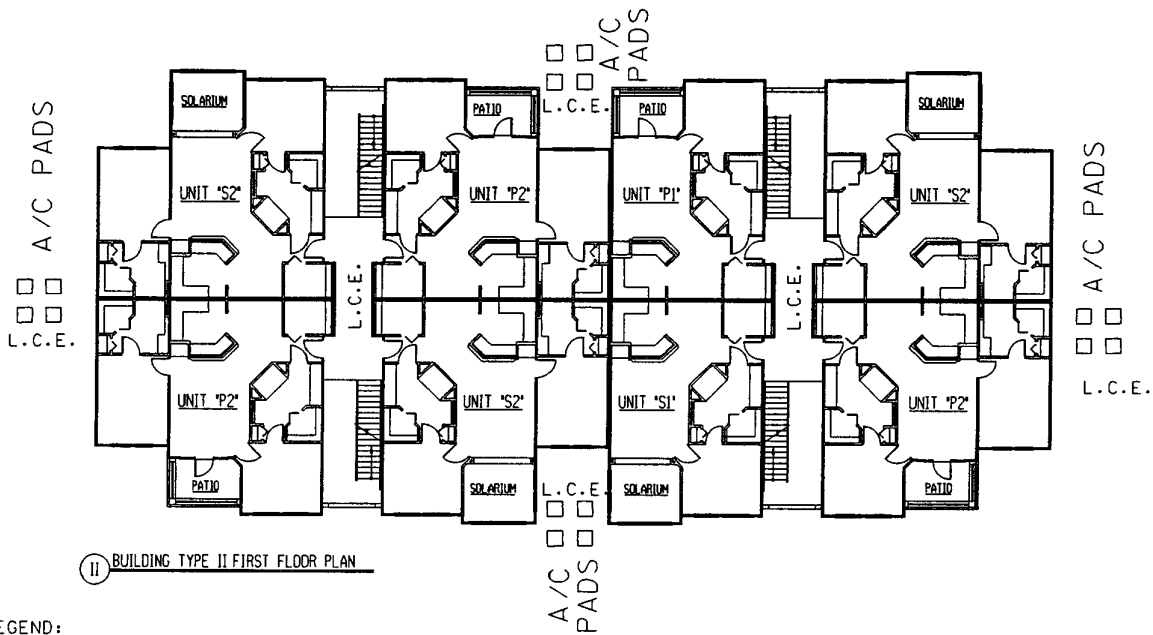

II BUILDING TYPE II FIRST FLOOR PLAN

LEGEND:  
 L.C.E. DENOTES LIMITED COMMON ELEMENT

BUILDING TYPE II BUILDINGS 14, 17, 18, 19.



Bessent, Hammack & Ruckman, Inc.  
 Engineers - Planners - Landscape Architects - Surveyors  
 1900 Corporate Square Boulevard  
 Jacksonville, Florida 32216  
 Phone (904) 721-2991 Fax (904) 725-0171  
 Certification Number LB 6739

EXHIBIT 'A'  
 SHEET 16 OF 41

JUNE 29, 2005  
 SCALE 1" = 30'

CONDOMINIUM DRAWINGS  
MONTEREY AT BEACH BOULEVARD,  
A CONDOMINIUM  
FLOOR PLAN

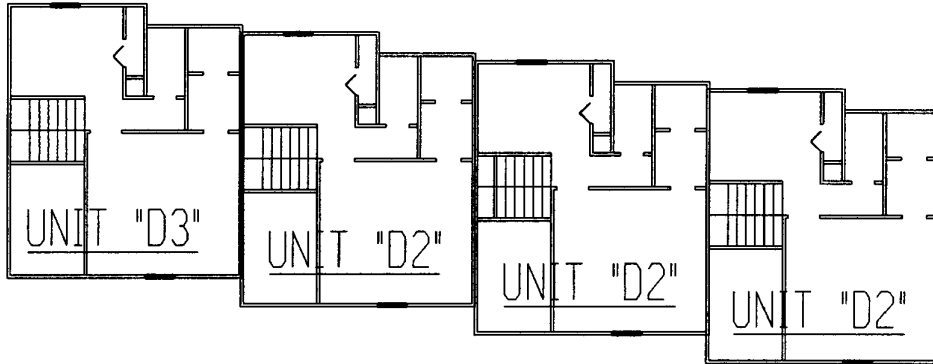

III BUILDING TYPE III - SECOND FLOOR PLAN

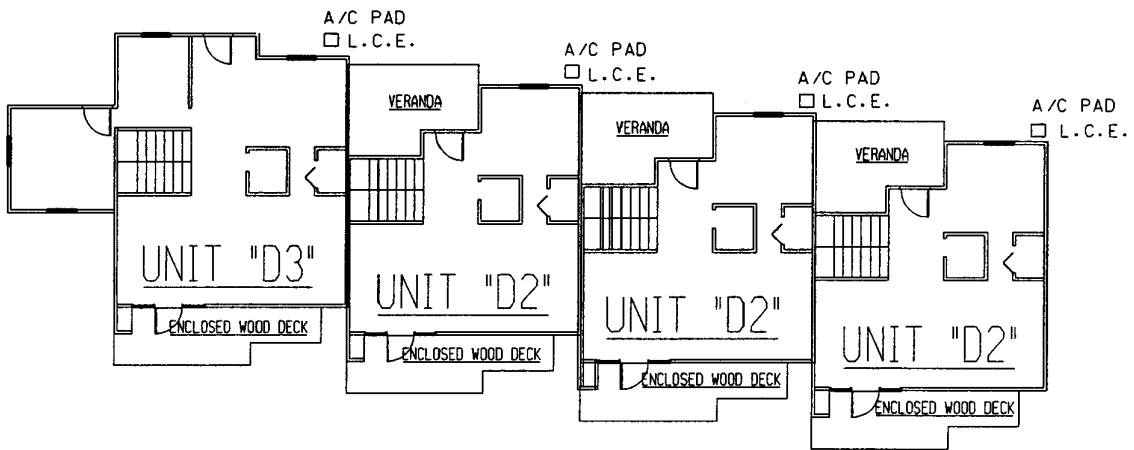

III BUILDING TYPE III - FIRST FLOOR PLAN

BUILDING TYPE III BUILDING 1



Bessent, Hammack & Ruckman, Inc.  
Engineers - Planners - Landscape Architects - Surveyors  
1900 Corporate Square Boulevard  
Jacksonville, Florida 32216  
Phone (904) 721-2991 Fax (904) 725-0171  
Certification Number LB 6739

LEGEND:  
L.C.E. DENOTES LIMITED COMMON ELEMENT

EXHIBIT 'A'  
SHEET 17 OF 41

JUNE 29, 2005  
SCALE 1" = 20'

CONDOMINIUM DRAWINGS  
 MONTEREY AT BEACH BOULEVARD,  
 A CONDOMINIUM  
 FLOOR PLAN

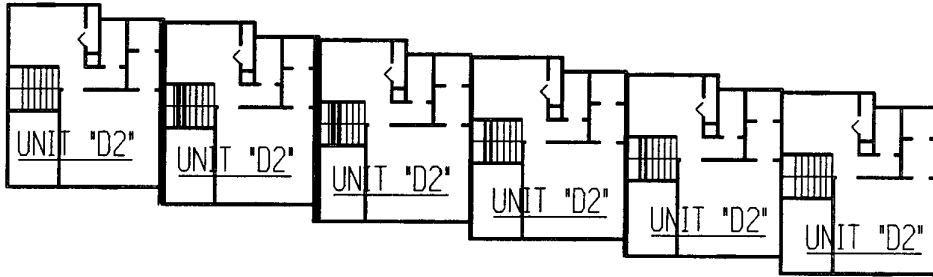

IV BUILDING TYPE IV - SECOND FLOOR PLAN

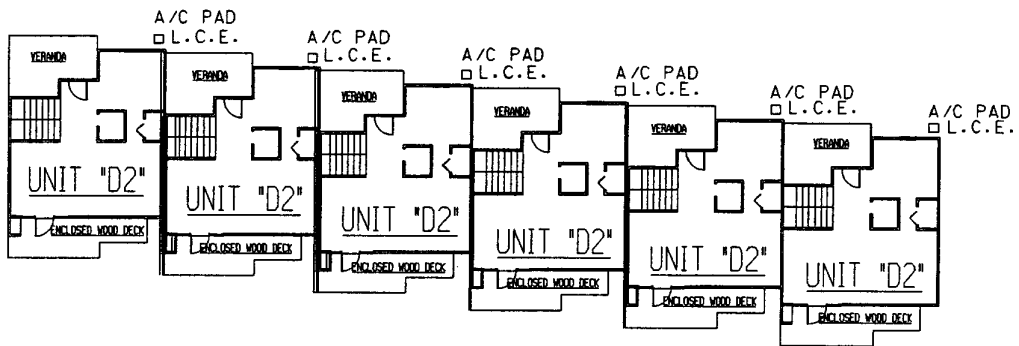

IV BUILDING TYPE IV - FIRST FLOOR PLAN

BUILDING TYPE IV BUILDINGS 2 & 4



Bessent, Hammack & Ruckman, Inc.  
 Engineers - Planners - Landscape Architects - Surveyors  
 1900 Corporate Square Boulevard  
 Jacksonville, Florida 32216  
 Phone (904) 721-2991 Fax (904) 725-0171  
 Certification Number LB 6739

LEGEND:  
 L.C.E. DENOTES LIMITED COMMON ELEMENT

EXHIBIT 'A'  
 SHEET 18 OF 41

JUNE 29, 2005  
 SCALE 1" = 30'



CONDOMINIUM DRAWINGS  
 MONTEREY AT BEACH BOULEVARD,  
 A CONDOMINIUM  
 FLOOR PLAN

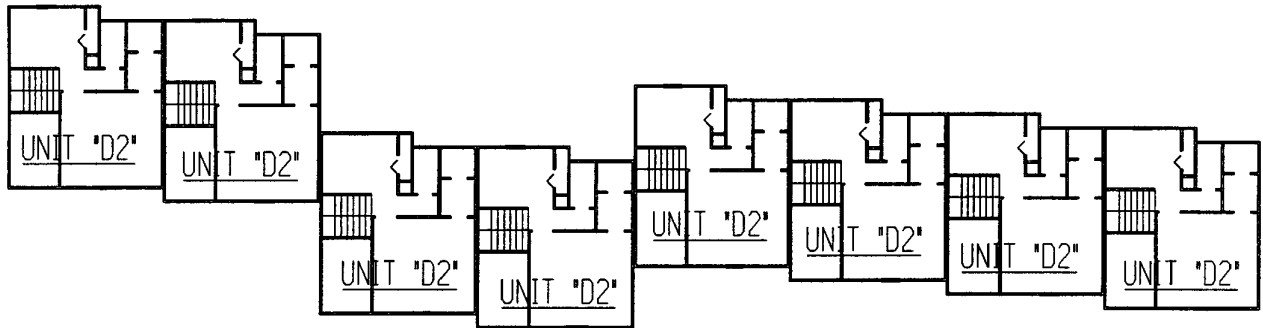

V BUILDING TYPE V - SECOND FLOOR PLAN

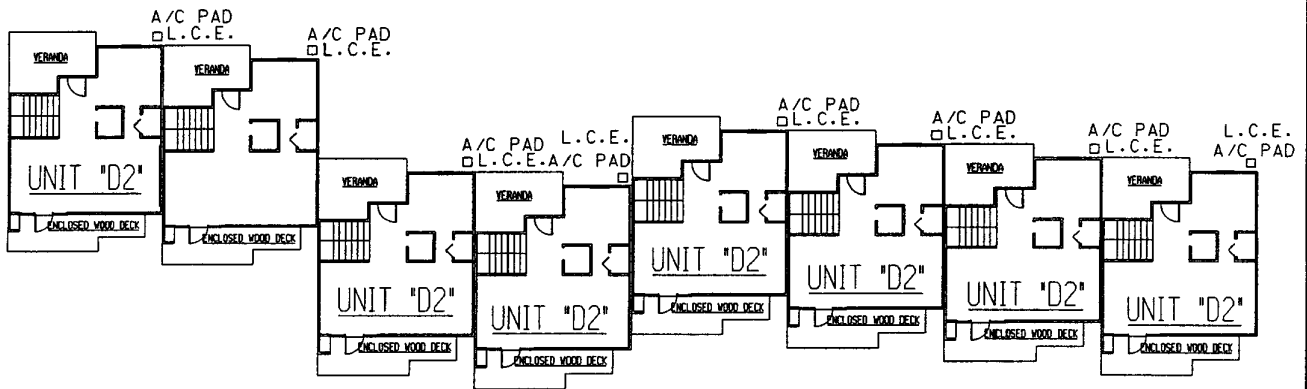

V BUILDING TYPE V - FIRST FLOOR PLAN

BUILDING TYPE V BUILDING 3



Bessent, Hammack & Ruckman, Inc.  
 Engineers - Planners - Landscape Architects - Surveyors  
 1900 Corporate Square Boulevard  
 Jacksonville, Florida 32216  
 Phone (904) 721-2991 Fax (904) 725-0171  
 Certification Number LB 6739

LEGEND:  
 L.C.E. DENOTES LIMITED COMMON ELEMENT

EXHIBIT 'A'  
 SHEET 19 OF 41

JUNE 29, 2005  
 SCALE 1" = 30'

CONDOMINIUM DRAWINGS  
 MONTEREY AT BEACH BOULEVARD,  
 A CONDOMINIUM  
 FLOOR PLAN

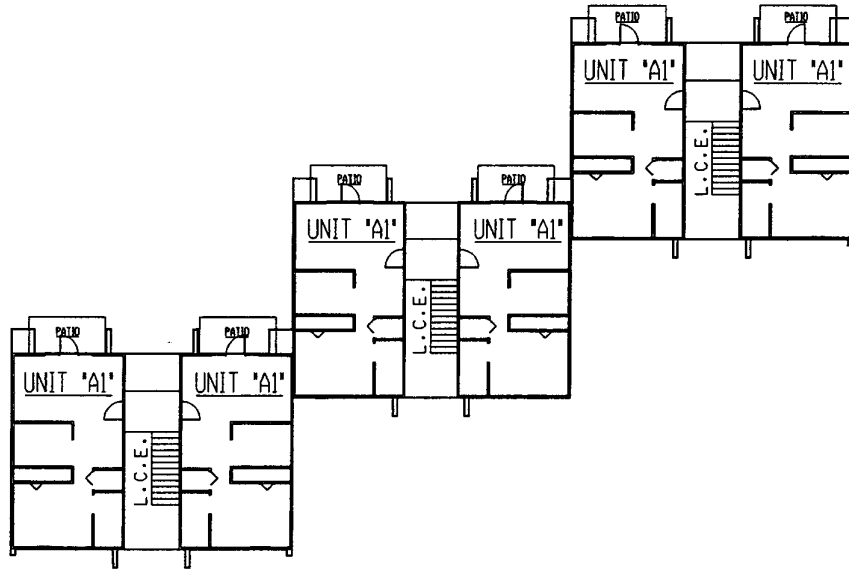

VI BUILDING TYPE VI - SECOND FLOOR PLAN

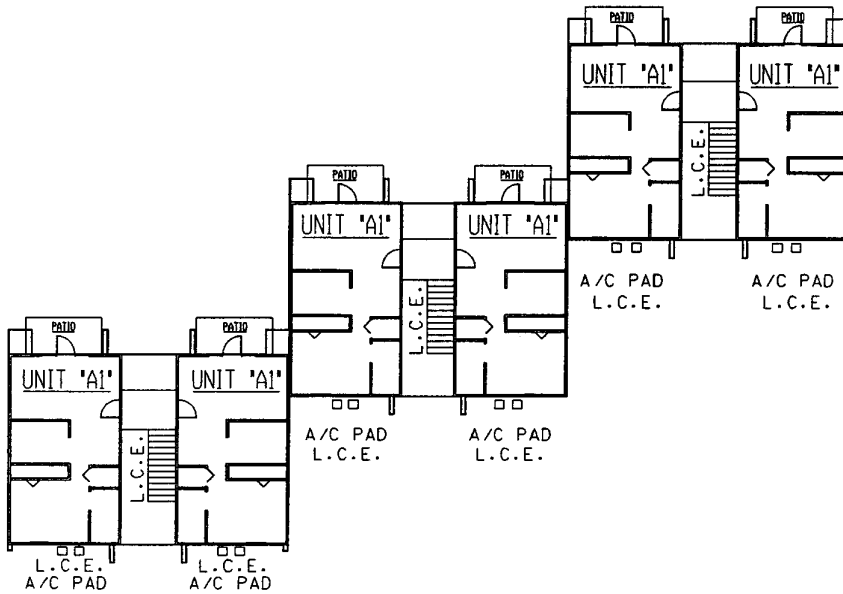

VI BUILDING TYPE VI - FIRST FLOOR PLAN  
 BUILDING TYPE VI BUILDING 5



Bessent, Hammack & Ruckman, Inc.  
 Engineers - Planners - Landscape Architects - Surveyors  
 1900 Corporate Square Boulevard  
 Jacksonville, Florida 32216  
 Phone (904) 721-2591 Fax (904) 725-0171  
 Certification Number LB 6739

LEGEND:  
 L.C.E. DENOTES LIMITED COMMON ELEMENT

EXHIBIT 'A'  
 SHEET 20 OF 41

JUNE 29, 2005  
 SCALE 1" = 30'

CONDOMINIUM DRAWINGS  
 MONTEREY AT BEACH BOULEVARD,  
 A CONDOMINIUM  
 FLOOR PLAN

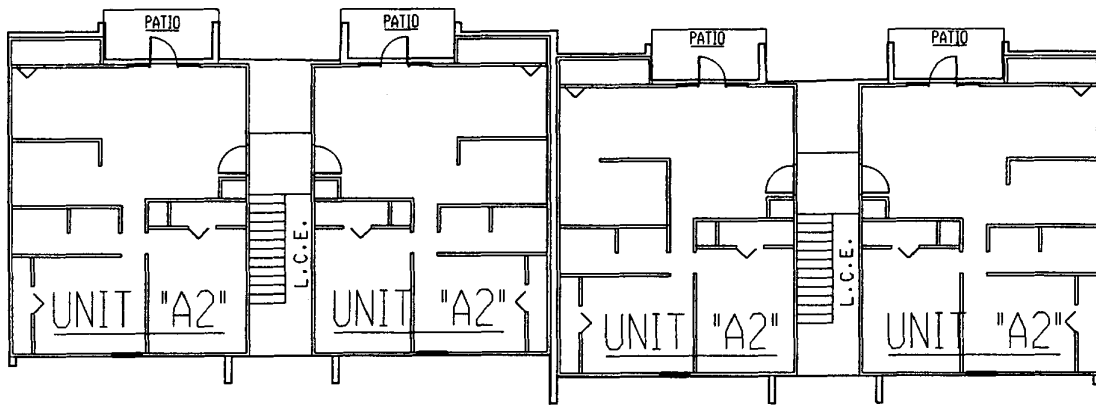

VII BUILDING TYPE VII - SECOND FLOOR PLAN

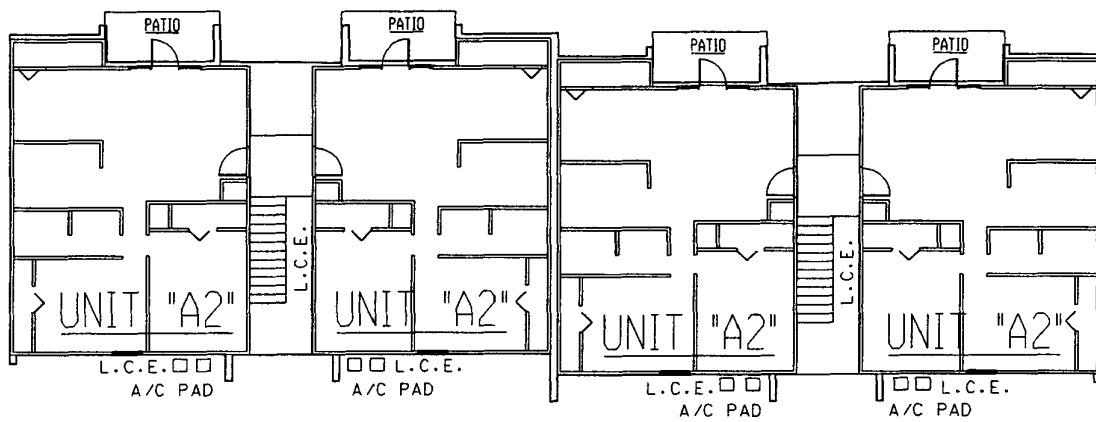

VII BUILDING TYPE VII - FIRST FLOOR PLAN

BUILDING TYPE VII BUILDINGS 6, 7, 8, 9, 12.



Bessent, Hammack & Ruckman, Inc.  
 Engineers - Planners - Landscape Architects - Surveyors  
 1900 Corporate Square Boulevard  
 Jacksonville, Florida 32216  
 Phone (904) 721-2991 Fax (904) 725-0171  
 Certification Number LB 6739

LEGEND:  
 L.C.E. DENOTES LIMITED COMMON ELEMENT

EXHIBIT 'A'  
 SHEET 21 OF 41

JUNE 29, 2005  
 SCALE 1" = 20'

CONDOMINIUM DRAWINGS  
 MONTEREY AT BEACH BOULEVARD,  
 A CONDOMINIUM  
 FLOOR PLAN

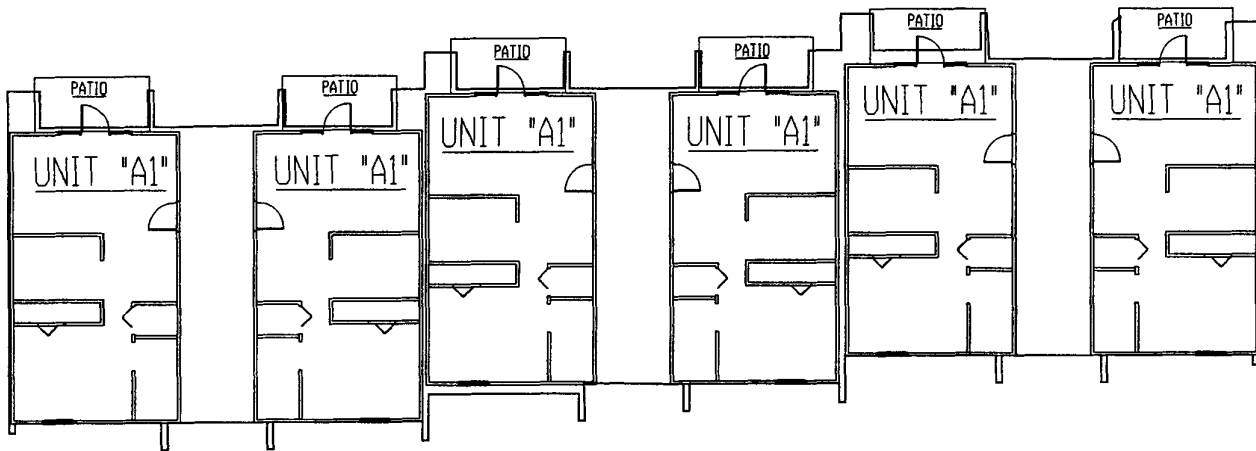

VIII BUILDING TYPE VIII - SECOND FLOOR PLAN

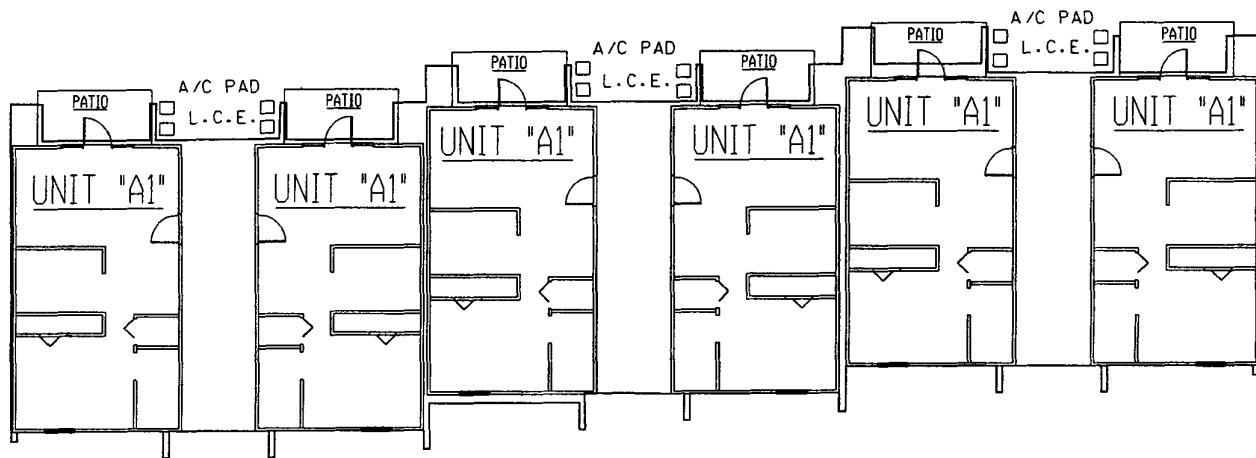

VIII BUILDING TYPE VIII - FIRST FLOOR PLAN

BUILDING TYPE VIII BUILDINGS 10, 11.



Bessent, Hammack & Ruckman, Inc.  
 Engineers - Planners - Landscape Architects - Surveyors  
 1900 Corporate Square Boulevard  
 Jacksonville, Florida 32216  
 Phone (904) 721-2991 Fax (904) 725-0171  
 Certification Number LB 6739

LEGEND:  
 L.C.E. DENOTES LIMITED COMMON ELEMENT

EXHIBIT 'A'  
 SHEET 22 OF 41

JUNE 29, 2005  
 SCALE 1" = 20'

CONDOMINIUM DRAWINGS  
MONTEREY AT BEACH BOULEVARD,  
A CONDOMINIUM  
FLOOR PLAN

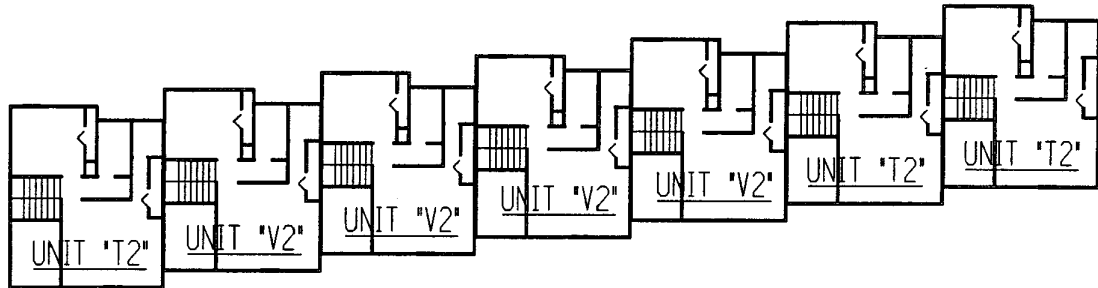

IX BUILDING TYPE IX - SECOND FLOOR PLAN

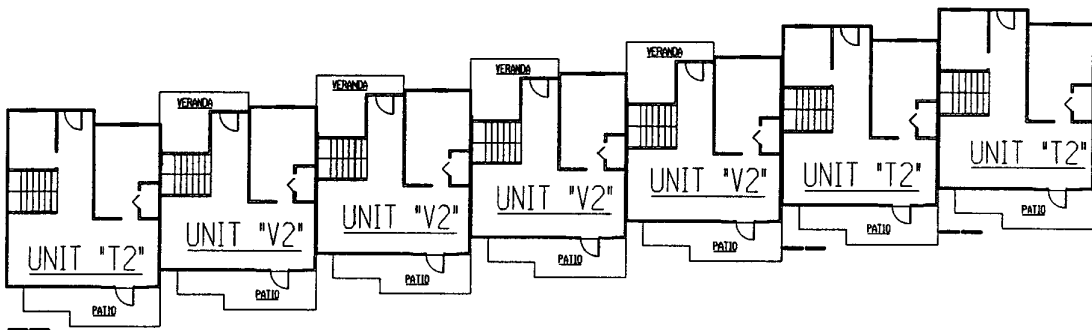

IX BUILDING TYPE IX - FIRST FLOOR PLAN  
BUILDING TYPE IX BUILDING 13



Bessent, Hammack & Ruckman, Inc.  
Engineers - Planners - Landscape Architects - Surveyors  
1900 Corporate Square Boulevard  
Jacksonville, Florida 32216  
Phone (904) 721-2591 Fax (904) 725-0171  
Certification Number LB 6739

LEGEND:  
L.C.E. DENOTES LIMITED COMMON ELEMENT

EXHIBIT 'A'  
SHEET 23 OF 41

JUNE 29, 2005  
SCALE 1" = 30'

**CONDOMINIUM DRAWINGS  
MONTEREY AT BEACH BOULEVARD,  
A CONDOMINIUM  
UNIT FLOOR PLAN**

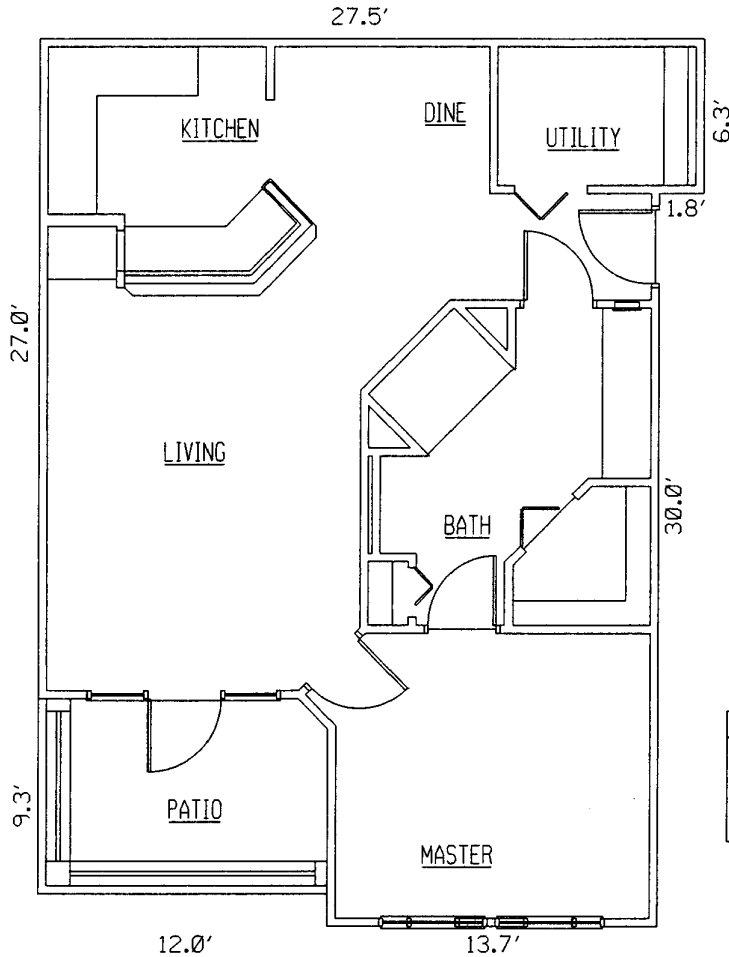

**GROSS AREA**

| 1 BEDROOM W/ PORCH UNIT P1 |                 |
|----------------------------|-----------------|
| DESCRIPTION                | SQUARE FEET     |
| HVAC                       | 833 S.F.        |
| PATIO                      | 95 S.F.         |
| <b>TOTAL S.F.</b>          | <b>928 S.F.</b> |

**1 UNIT TYPE P1  
1 BEDROOM FLOOR PLAN W/ PATIO**

**UNIT NUMBERS 1416, 1426, 1516, 1526, 1616, 1626,  
1716, 1726, 1816, 1826, 1916, 1926.**

**NOTES:**

1. L.C.E. DENOTES LIMITED COMMON ELEMENT
2. S.F. DENOTES SQUARE FEET
3. INTERIOR UNIT MODIFICATION MAY CHANGE UNIT LAYOUT (I.E. DOORWAYS MOVED, CLOSET SIZE CHANGED, BATHROOM ENLARGED), HOWEVER OUTSIDE DIMENSIONS AND AREAS REMAIN THE SAME FOR UNIT TYPE.



**Bessent, Hammack & Ruckman, Inc.**  
Engineers - Planners - Landscape Architects - Surveyors  
1980 Corporate Square Boulevard  
Jacksonville, Florida 32216  
Phone (904) 721-2991 Fax (904) 725-0171  
Certification Number LB 6739

**EXHIBIT 'A'**  
SHEET 24 OF 41

AUGUST 26, 2005  
SCALE 1" = 7.5'

**CONDOMINIUM DRAWINGS  
MONTEREY AT BEACH BOULEVARD,  
A CONDOMINIUM  
UNIT FLOOR PLAN**

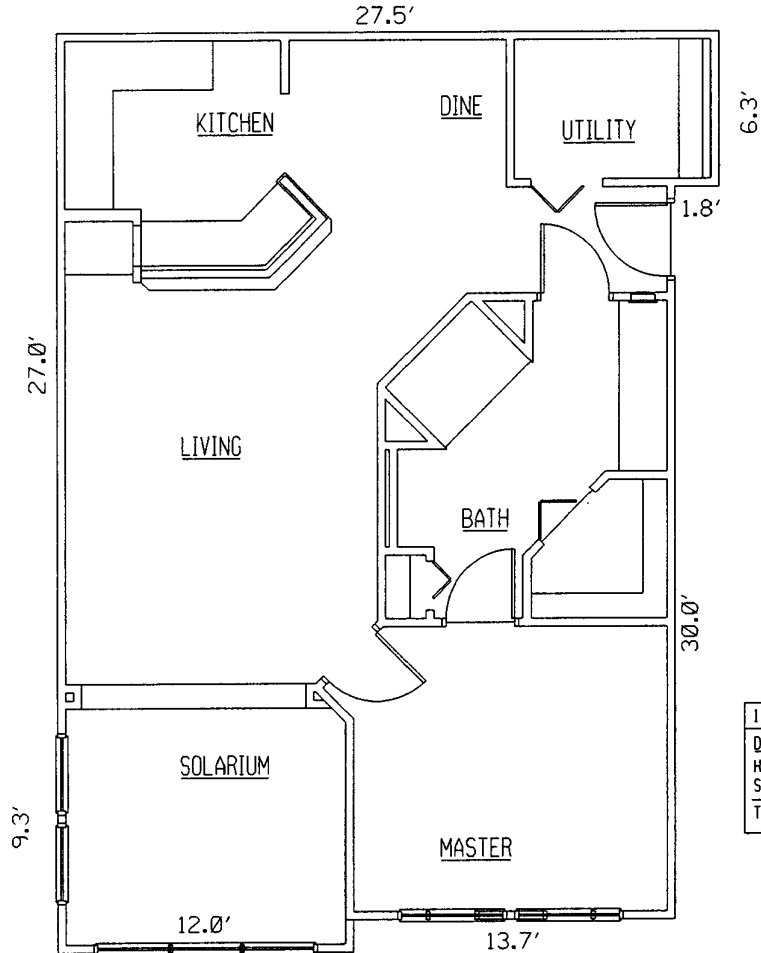

**GROSS AREA**

| DESCRIPTION       | SQUARE FEET     |
|-------------------|-----------------|
| HVAC              | 833 S.F.        |
| SOLARIUM          | 132 S.F.        |
| <b>TOTAL S.F.</b> | <b>965 S.F.</b> |

**1** UNIT TYPE S1  
**1 BEDROOM FLOOR PLAN W/ SOLARIUM**

**UNIT NUMBERS 1415, 1425, 1515, 1525, 1615, 1625,  
1715, 1725, 1815, 1825, 1915, 1925.**

- NOTES:**
1. L.C.E. DENOTES LIMITED COMMON ELEMENT
  2. S.F. DENOTES SQUARE FEET
  3. INTERIOR UNIT MODIFICATION MAY CHANGE UNIT LAYOUT (i.e. DOORWAYS MOVED, CLOSET SIZE CHANGED, BATHROOM ENLARGED), HOWEVER OUTSIDE DIMENSIONS AND AREAS REMAIN THE SAME FOR UNIT TYPE.



**Bessent, Hammack & Ruckman, Inc.**  
Engineers - Planners - Landscape Architects - Surveyors  
1900 Corporate Square Boulevard  
Jacksonville, Florida 32216  
Phone (904) 721-2591 Fax (904) 725-0171  
Certification Number LB 6739

**EXHIBIT 'A'**  
SHEET 25 OF 41

AUGUST 26, 2005  
SCALE 1" = 7.5'

CONDOMINIUM DRAWINGS  
 MONTEREY AT BEACH BOULEVARD,  
 A CONDOMINIUM  
 UNIT FLOOR PLAN

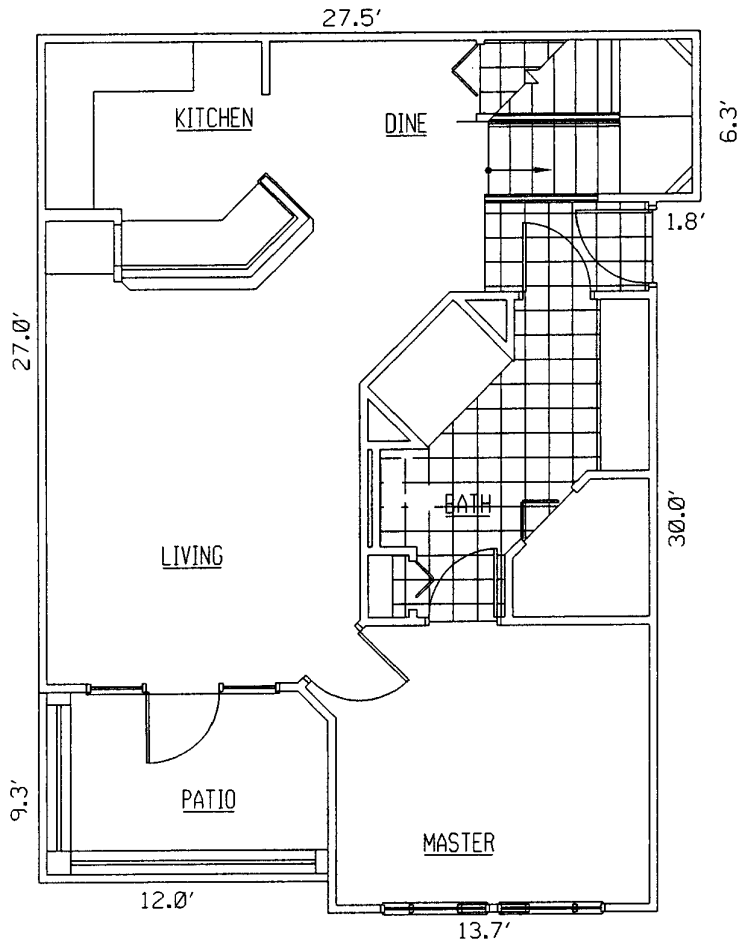
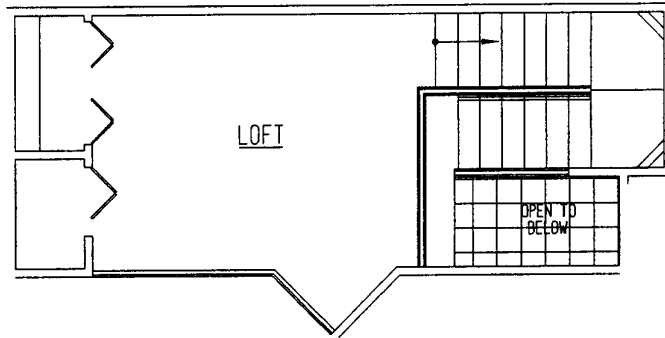

GROSS AREA

| DESCRIPTION    | SQUARE FEET |
|----------------|-------------|
| 1st FLOOR HVAC | 833 S.F.    |
| LOFT HVAC      | 198 S.F.    |
| TOTAL HVAC     | 1,031 S.F.  |
| PATIO          | 95 S.F.     |
| TOTAL S.F.     | 1,126 S.F.  |

1 UNIT TYPE P1L  
 1 BEDROOM FLOOR PLAN, LOFT W/ PATIO

UNIT NUMBERS 1531, 1536, 1537,  
 1631, 1636, 1637.

- NOTES:
1. L.C.E. DENOTES LIMITED COMMON ELEMENT
  2. S.F. DENOTES SQUARE FEET
  3. INTERIOR UNIT MODIFICATION MAY CHANGE UNIT LAYOUT (i.e. DOORWAYS MOVED, CLOSET SIZE CHANGED, BATHROOM ENLARGED). HOWEVER OUTSIDE DIMENSIONS AND AREAS REMAIN THE SAME FOR UNIT TYPE.



Bessent, Hammack & Ruckman, Inc.  
 Engineers - Planners - Landscape Architects - Surveyors  
 1900 Corporate Square Boulevard  
 Jacksonville, Florida 32216  
 Phone (904) 721-2991 Fax (904) 725-0171  
 Certification Number LB 6739

EXHIBIT 'A'  
 SHEET 26 OF 41

AUGUST 26, 2005  
 SCALE 1" = 7.5'



CONDOMINIUM DRAWINGS  
 MONTEREY AT BEACH BOULEVARD,  
 A CONDOMINIUM  
 UNIT FLOOR PLAN

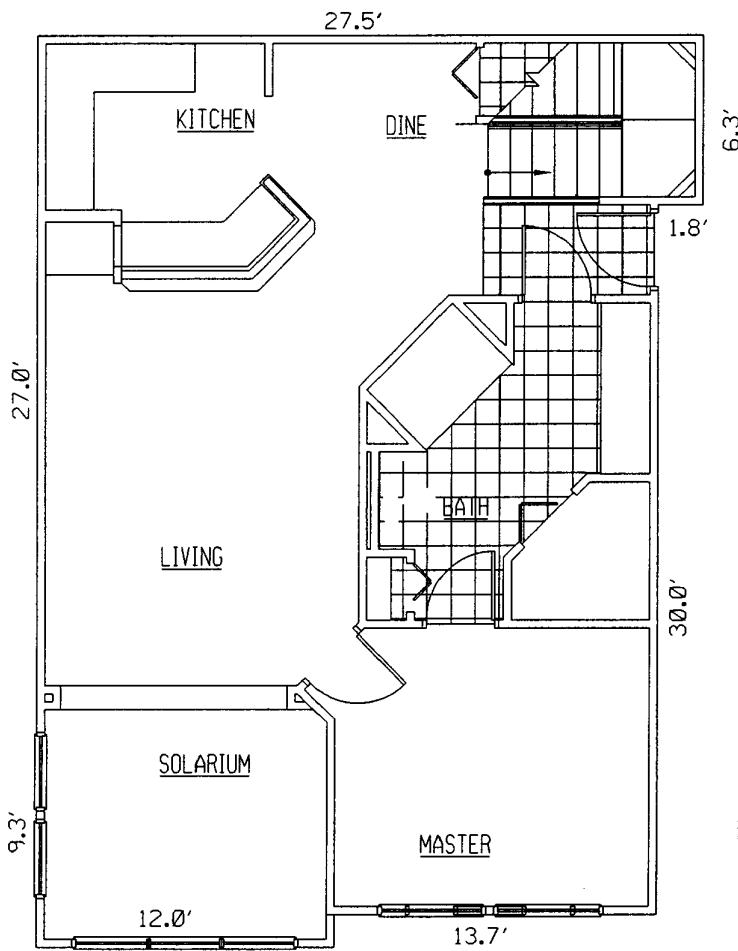
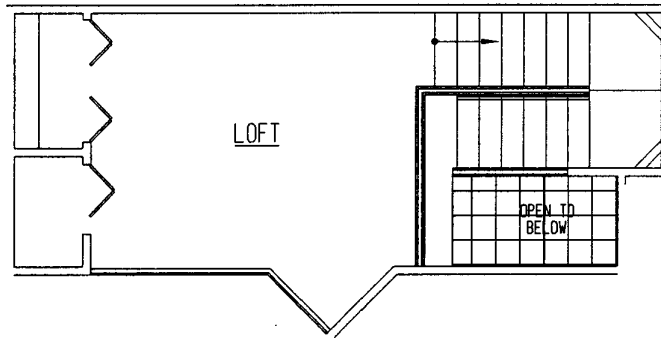

GROSS AREA

| 1 BEDROOM LOFT W/ SOLARIUM UNIT SIL |             |
|-------------------------------------|-------------|
| DESCRIPTION                         | SQUARE FEET |
| 1st FLOOR HVAC                      | 833 S.F.    |
| LOFT HVAC                           | 198 S.F.    |
| TOTAL HVAC                          | 1,031 S.F.  |
| SOLARIUM                            | 132 S.F.    |
| TOTAL S.F.                          | 1,163 S.F.  |

1 UNIT TYPE S1L  
 1 BEDROOM FLOOR PLAN, LOFT W/ SOLARIUM

UNIT NUMBERS 1532, 1535, 1538,  
 1632, 1635, 1638.

- NOTES:
1. L.C.E. DENOTES LIMITED COMMON ELEMENT
  2. S.F. DENOTES SQUARE FEET
  3. INTERIOR UNIT MODIFICATION MAY CHANGE UNIT LAYOUT (I.E. DOORWAYS MOVED, CLOSET SIZE CHANGED, BATHROOM ENLARGED), HOWEVER OUTSIDE DIMENSIONS AND AREAS REMAIN THE SAME FOR UNIT TYPE.



**Bessent, Hammack & Ruckman, Inc.**  
 Engineers - Planners - Landscape Architects - Surveyors  
 1900 Corporate Square Boulevard  
 Jacksonville, Florida 32216  
 Phone (904) 721-2991 Fax (904) 725-0171  
 Certification Number LB 6739

EXHIBIT 'A'  
 SHEET 27 OF 41

AUGUST 26, 2005  
 SCALE 1" = 7.5'



CONDOMINIUM DRAWINGS  
 MONTEREY AT BEACH BOULEVARD,  
 A CONDOMINIUM  
 UNIT FLOOR PLAN

GROSS AREA

| 2 BEDROOM W/ SOLARIUM UNIT S2 |             |
|-------------------------------|-------------|
| DESCRIPTION                   | SQUARE FEET |
| HVAC                          | 1,133 S.F.  |
| SOLARIUM                      | 132 S.F.    |
| TOTAL S.F.                    | 1,265 S.F.  |

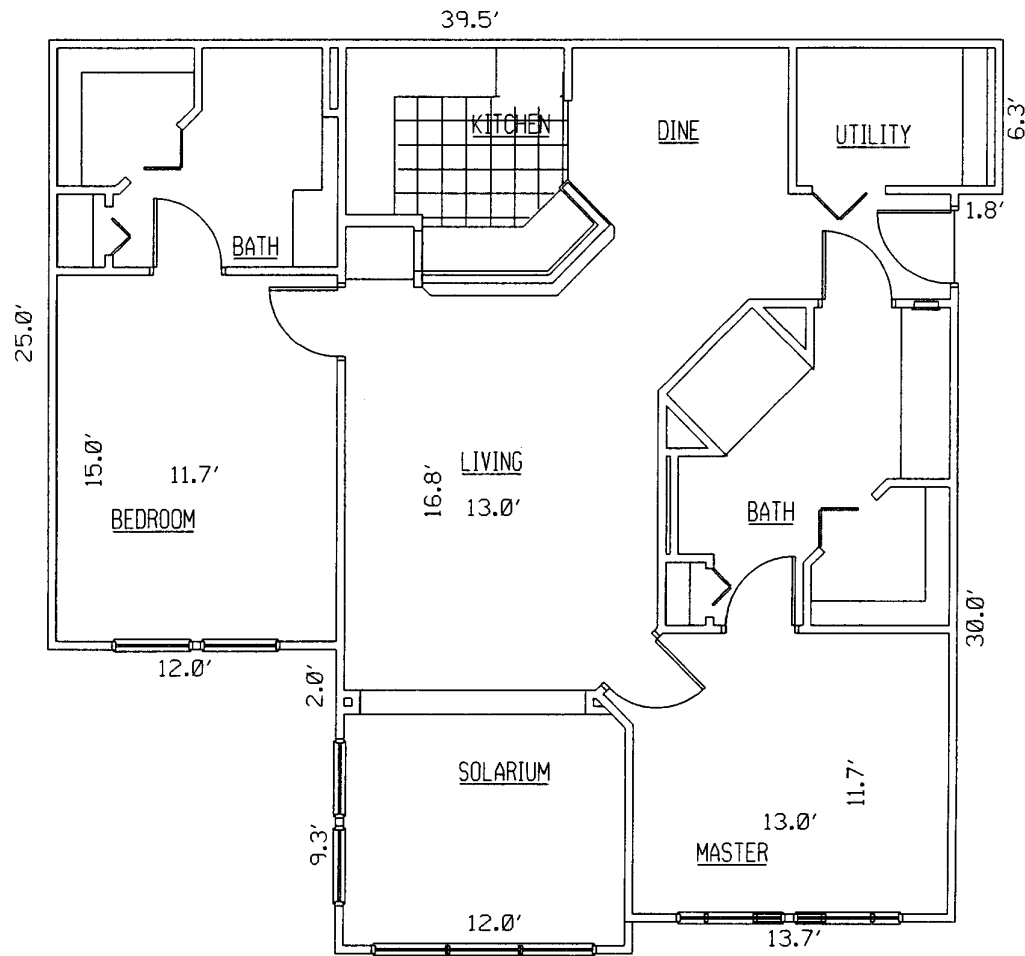

② UNIT TYPE S2  
 2 BEDROOM 2 BATH FLOOR PLAN W/ SOLARIUM

UNIT NUMBERS 1412, 1413, 1418, 1422, 1423, 1428,  
 1513, 1523, 1613, 1623, 1712, 1713, 1718, 1722, 1723,  
 1728, 1812, 1813, 1818, 1822, 1823, 1828, 1912, 1913,  
 1918, 1922, 1923, 1928.

- NOTES:
1. L.C.E. DENOTES LIMITED COMMON ELEMENT
  2. S.F. DENOTES SQUARE FEET
  3. INTERIOR UNIT MODIFICATION MAY CHANGE UNIT LAYOUT (I.E. DOORWAYS MOVED, CLOSET SIZE CHANGED, BATHROOM ENLARGED), HOWEVER OUTSIDE DIMENSIONS AND AREAS REMAIN THE SAME FOR UNIT TYPE.



**Bessent, Hammack & Ruckman, Inc.**  
 Engineers - Planners - Landscape Architects - Surveyors  
 1900 Corporate Square Boulevard  
 Jacksonville, Florida 32216  
 Phone (904) 721-2591 Fax (904) 725-0171  
 Certification Number LB 6739

EXHIBIT 'A'  
 SHEET 29 OF 41

AUGUST 26, 2005  
 SCALE 1" = 7.5'

CONDOMINIUM DRAWINGS  
 MONTEREY AT BEACH BOULEVARD,  
 A CONDOMINIUM  
 UNIT FLOOR PLAN

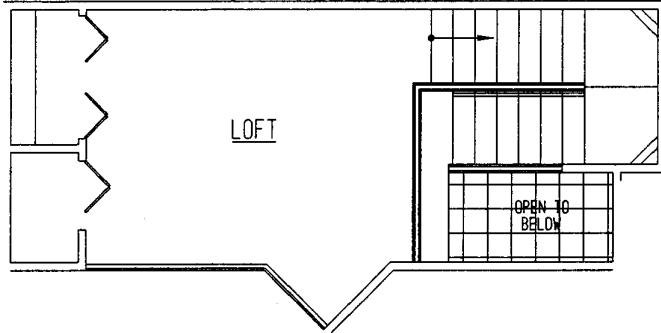

GROSS AREA

| DESCRIPTION    | SQUARE FEET |
|----------------|-------------|
| 1st FLOOR HVAC | 1,134 S.F.  |
| LOFT HVAC      | 198 S.F.    |
| TOTAL HVAC     | 1,332 S.F.  |
| PATIO          | 95 S.F.     |
| TOTAL S.F.     | 1,427 S.F.  |

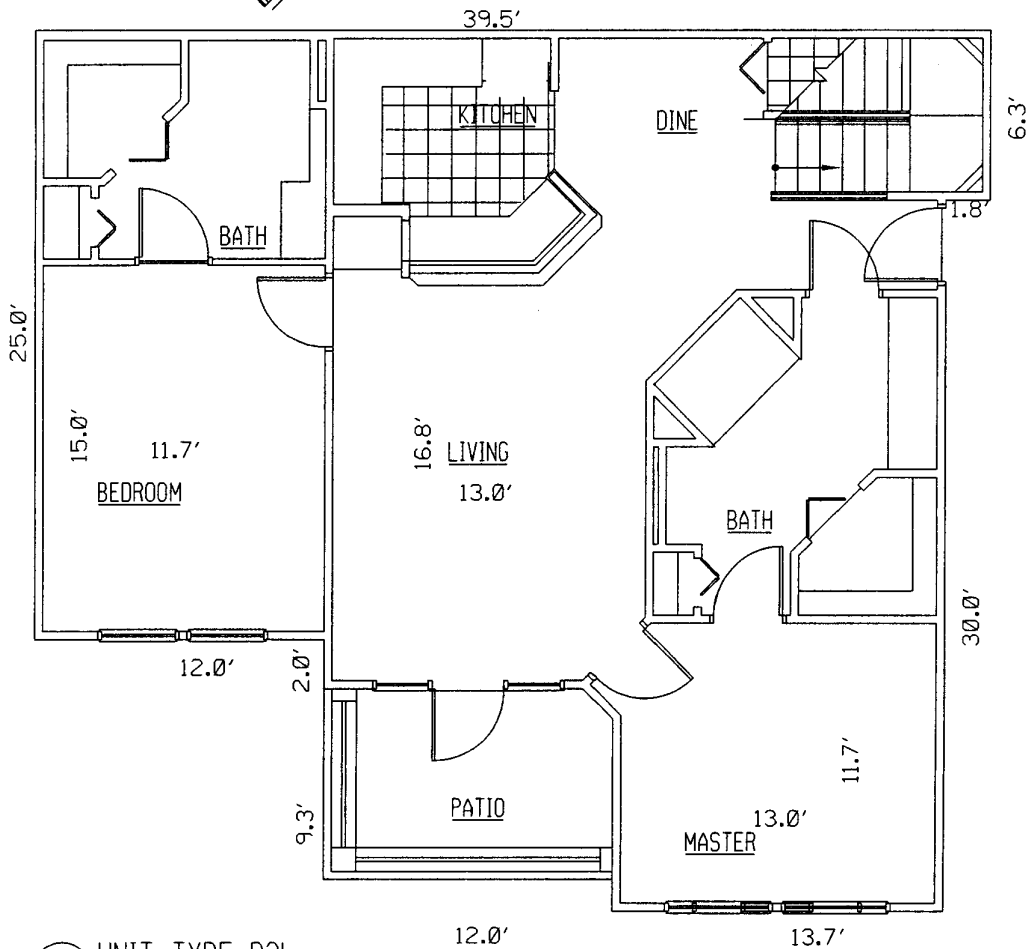

2 UNIT TYPE P2L  
 2 BEDROOM FLOOR PLAN, LOFT W/ PATIO

UNIT NUMBERS 1534, 1634.

NOTES:

1. L.C.E. DENOTES LIMITED COMMON ELEMENT
2. S.F. DENOTES SQUARE FEET
3. INTERIOR UNIT MODIFICATION MAY CHANGE UNIT LAYOUT (i.e. DOORWAYS MOVED, CLOSET SIZE CHANGED, BATHROOM ENLARGED), HOWEVER OUTSIDE DIMENSIONS AND AREAS REMAIN THE SAME FOR UNIT TYPE.



**Bessent, Hammack & Ruckman, Inc.**  
 Engineers - Planners - Landscape Architects - Surveyors  
 1900 Corporate Square Boulevard  
 Jacksonville, Florida 32216  
 Phone (904) 721-2991 Fax (904) 725-0171  
 Certification Number LB 6739

EXHIBIT 'A'  
 SHEET 30 OF 41

AUGUST 26, 2005  
 SCALE 1" = 7.5'

CONDOMINIUM DRAWINGS  
 MONTEREY AT BEACH BOULEVARD,  
 A CONDOMINIUM  
 UNIT FLOOR PLAN

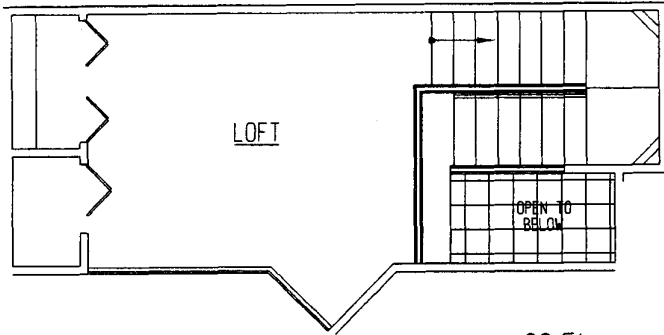

GROSS AREA

| 2 BEDROOM LOFT W/ SOLARIUM UNIT S2L |             |
|-------------------------------------|-------------|
| DESCRIPTION                         | SQUARE FEET |
| 1st FLOOR HVAC                      | 1,134 S.F.  |
| LOFT HVAC                           | 198 S.F.    |
| TOTAL HVAC                          | 1,332 S.F.  |
| SOLARIUM                            | 132 S.F.    |
| TOTAL S.F.                          | 1,464 S.F.  |

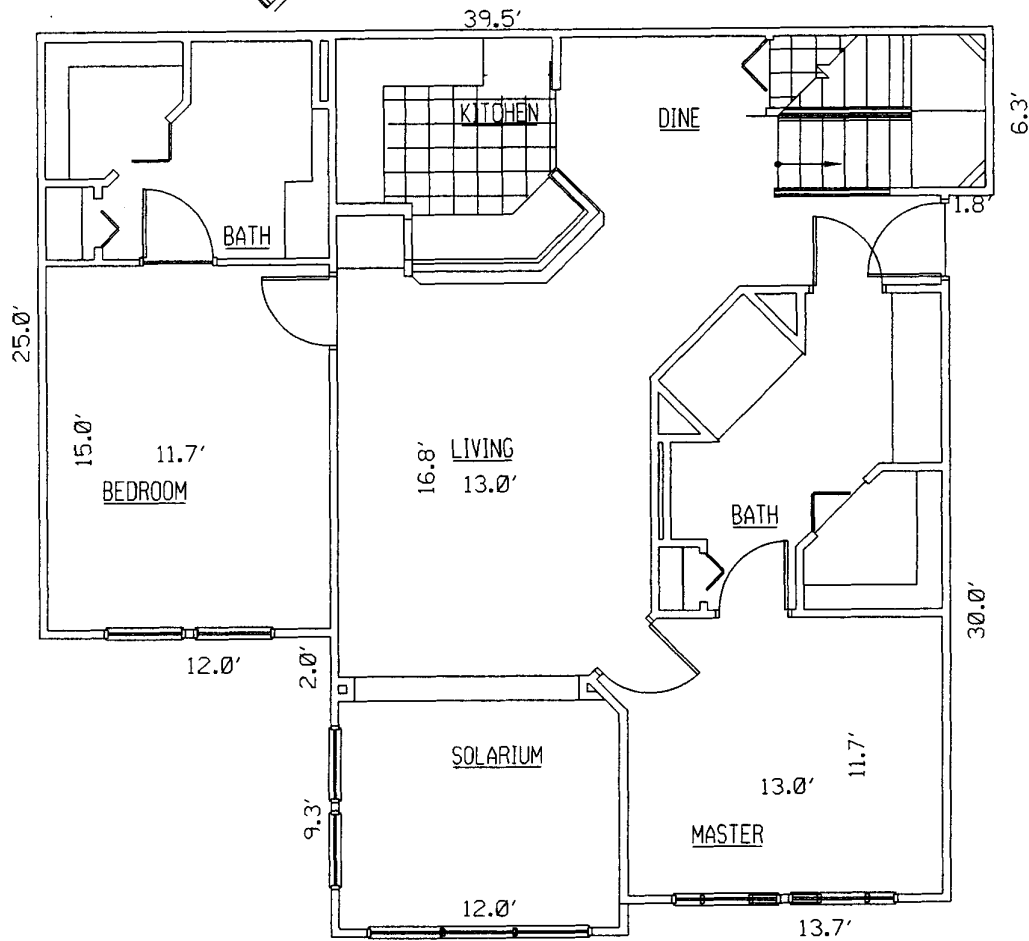

② UNIT TYPE S2L  
 2 BEDROOM FLOOR PLAN, LOFT W/ SOLARIUM  
 UNIT NUMBERS 1533, 1633.

- NOTES:
1. L.C.E. DENOTES LIMITED COMMON ELEMENT
  2. S.F. DENOTES SQUARE FEET
  3. INTERIOR UNIT MODIFICATION MAY CHANGE UNIT LAYOUT (i.e. DOORWAYS MOVED, CLOSET SIZE CHANGED, BATHROOM ENLARGED), HOWEVER OUTSIDE DIMENSIONS AND AREAS REMAIN THE SAME FOR UNIT TYPE.



**Bessent, Hammack & Ruckman, Inc.**  
 Engineers - Planners - Landscape Architects - Surveyors  
 1900 Corporate Square Boulevard  
 Jacksonville, Florida 32216  
 Phone (904) 721-2991 Fax (904) 725-0171  
 Certification Number LB 6739

EXHIBIT 'A'  
 SHEET 31 OF 41

AUGUST 26, 2005  
 SCALE 1" = 7.5'

CONDOMINIUM DRAWINGS  
 MONTEREY AT BEACH BOULEVARD,  
 A CONDOMINIUM  
 UNIT FLOOR PLAN

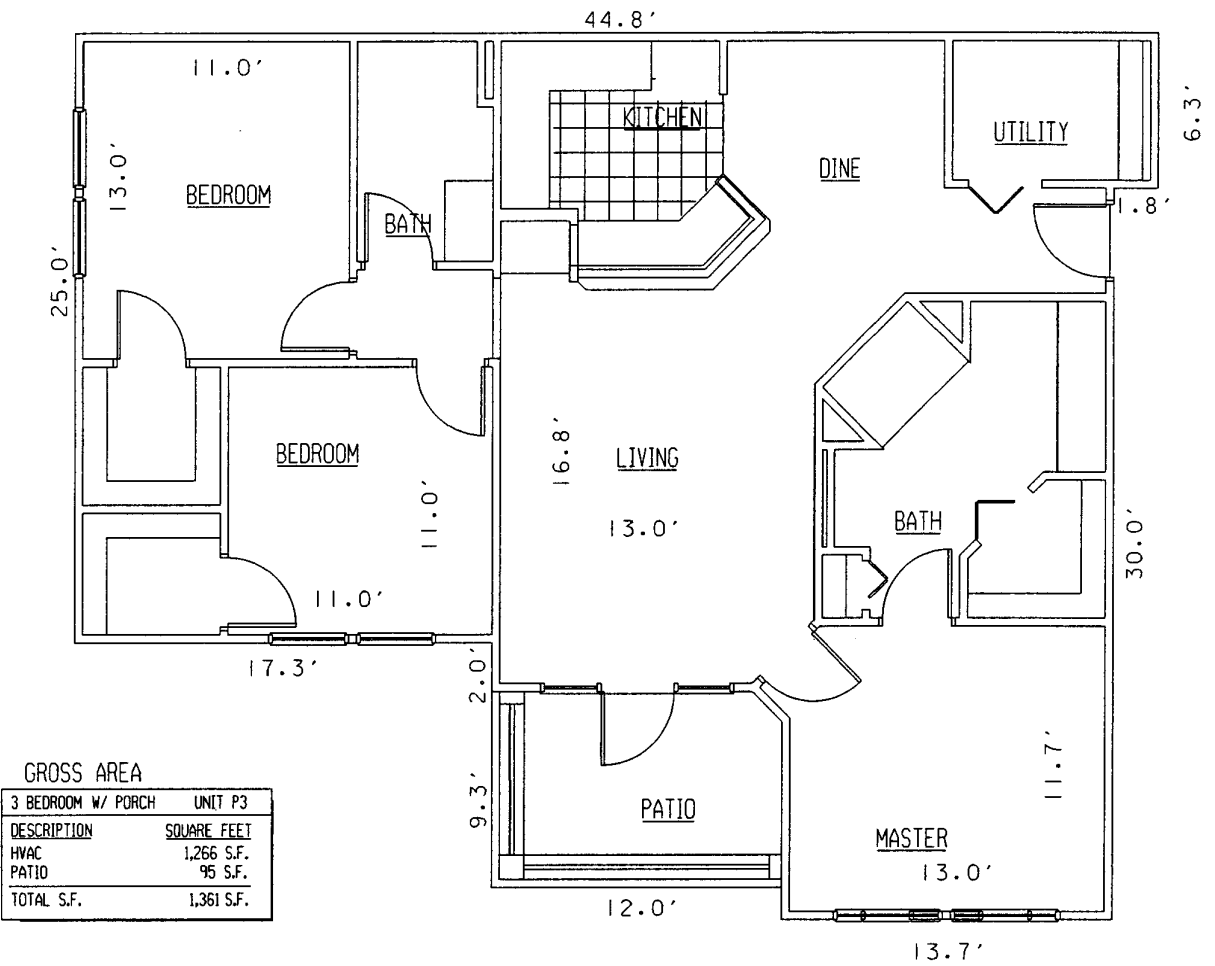

3 UNIT TYPE P3  
 3 BEDROOM FLOOR PLAN W/ PORCH

UNIT NUMBERS 1511, 1517, 1521,  
 1527, 1611, 1617, 1621, 1627.



**Bessent, Hammack & Ruckman, Inc.**  
 Engineers - Planners - Landscape Architects - Surveyors  
 1900 Corporate Square Boulevard  
 Jacksonville, Florida 32216  
 Phone (904) 721-2991 Fax (904) 725-0171  
 Certification Number LB 6739

- NOTES:
1. L.C.E. DENOTES LIMITED COMMON ELEMENT
  2. S.F. DENOTES SQUARE FEET
  3. INTERIOR UNIT MODIFICATION MAY CHANGE UNIT LAYOUT (I.e. DOORWAYS MOVED, CLOSET SIZE CHANGED, BATHROOM ENLARGED), HOWEVER OUTSIDE DIMENSIONS AND AREAS REMAIN THE SAME FOR UNIT TYPE.

EXHIBIT 'A'  
 SHEET 32 OF 41

AUGUST 26, 2005  
 SCALE 1" = 7.5'

CONDOMINIUM DRAWINGS  
 MONTEREY AT BEACH BOULEVARD,  
 A CONDOMINIUM  
 UNIT FLOOR PLAN

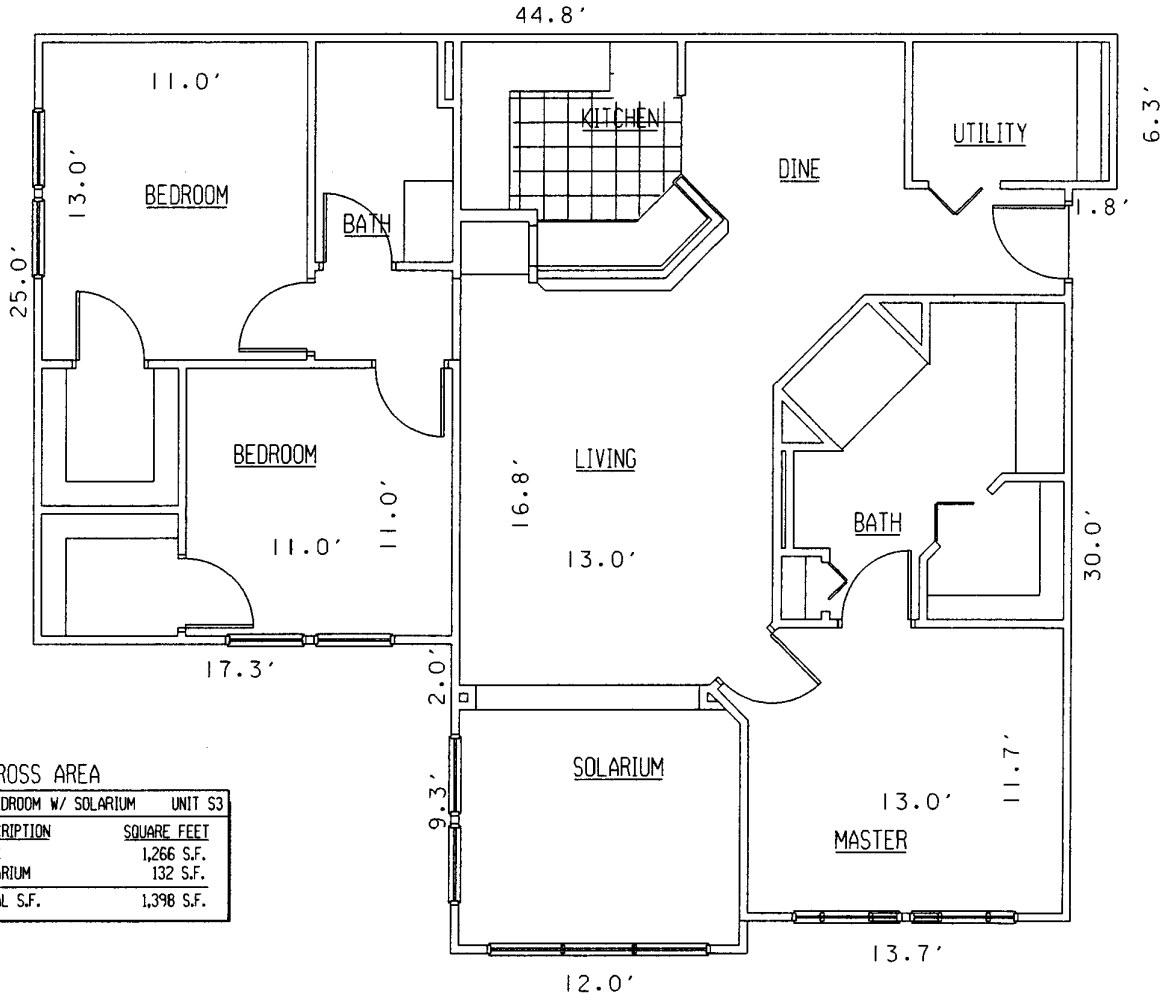

GROSS AREA

| DESCRIPTION           | SQUARE FEET |
|-----------------------|-------------|
| 3 BEDROOM W/ SOLARIUM | UNIT S3     |
| HVAC                  | 1,266 S.F.  |
| SOLARIUM              | 132 S.F.    |
| TOTAL S.F.            | 1,398 S.F.  |

3 UNIT TYPE S3  
 3 BEDROOM FLOOR PLAN W/ SOLARIUM

UNIT NUMBERS 1512, 1518, 1522,  
 1528, 1612, 1618, 1622, 1628.

- NOTES:
1. L.C.E. DENOTES LIMITED COMMON ELEMENT
  2. S.F. DENOTES SQUARE FEET
  3. INTERIOR UNIT MODIFICATION MAY CHANGE UNIT LAYOUT (I.E. DOORWAYS MOVED, CLOSET SIZE CHANGED, BATHROOM ENLARGED), HOWEVER OUTSIDE DIMENSIONS AND AREAS REMAIN THE SAME FOR UNIT TYPE.

**BHR**  
 Bessent, Hammack & Ruckman, Inc.  
 Engineers - Planners - Landscape Architects - Surveyors  
 1900 Corporate Square Boulevard  
 Jacksonville, Florida 32216  
 Phone (904) 721-2991 Fax (904) 725-0171  
 Certification Number LB 6739

EXHIBIT 'A'  
 SHEET 33 OF 41

AUGUST 26, 2005  
 SCALE 1" = 7.5'

**CONDOMINIUM DRAWINGS  
MONTEREY AT BEACH BOULEVARD,  
A CONDOMINIUM  
UNIT FLOOR PLAN**

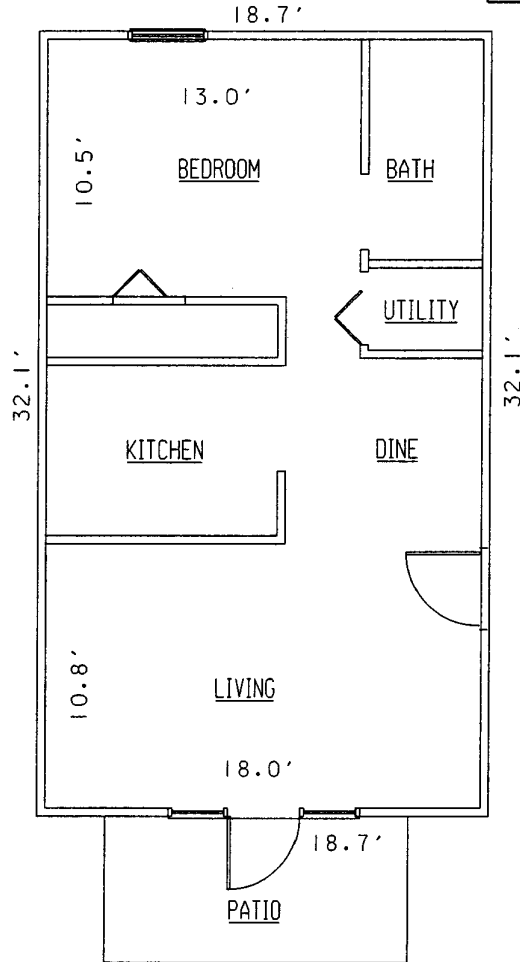

**1** UNIT TYPE A1  
1 BEDROOM FLOOR PLAN W/ PATIO

**UNIT NUMBERS 501, 502, 503, 504, 505, 506, 507,  
508, 509, 510, 511, 512, 1001, 1002, 1003, 1004, 1005,  
1006, 1007, 1008, 1009, 1010, 1011, 1012, 1101, 1102,  
1103, 1104, 1105, 1106, 1107, 1108, 1109, 1110, 1111, 1112.**

**GROSS AREA**

| DESCRIPTION                | SQUARE FEET     |
|----------------------------|-----------------|
| 1 BEDROOM W/ PATIO UNIT A1 |                 |
| HVAC                       | 600 S.F.        |
| PATIO                      | 76 S.F.         |
| <b>TOTAL S.F.</b>          | <b>676 S.F.</b> |

**NOTES:**

1. L.C.E. DENOTES LIMITED COMMON ELEMENT
2. S.F. DENOTES SQUARE FEET
3. INTERIOR UNIT MODIFICATION MAY CHANGE UNIT LAYOUT (i.e. DOORWAYS MOVED, CLOSET SIZE CHANGED, BATHROOM ENLARGED), HOWEVER OUTSIDE DIMENSIONS AND AREAS REMAIN THE SAME FOR UNIT TYPE.



**Bessent, Hammack & Ruckman, Inc.**  
Engineers - Planners - Landscape Architects - Surveyors  
1900 Corporate Square Boulevard  
Jacksonville, Florida 32216  
Phone (904) 721-2991 Fax (904) 725-0171  
Certification Number LB 6739

**EXHIBIT 'A'**  
SHEET 34 OF 41

AUGUST 26, 2005  
SCALE 1" = 7.5'



CONDOMINIUM DRAWINGS  
 MONTEREY AT BEACH BOULEVARD,  
 A CONDOMINIUM  
 UNIT FLOOR PLAN

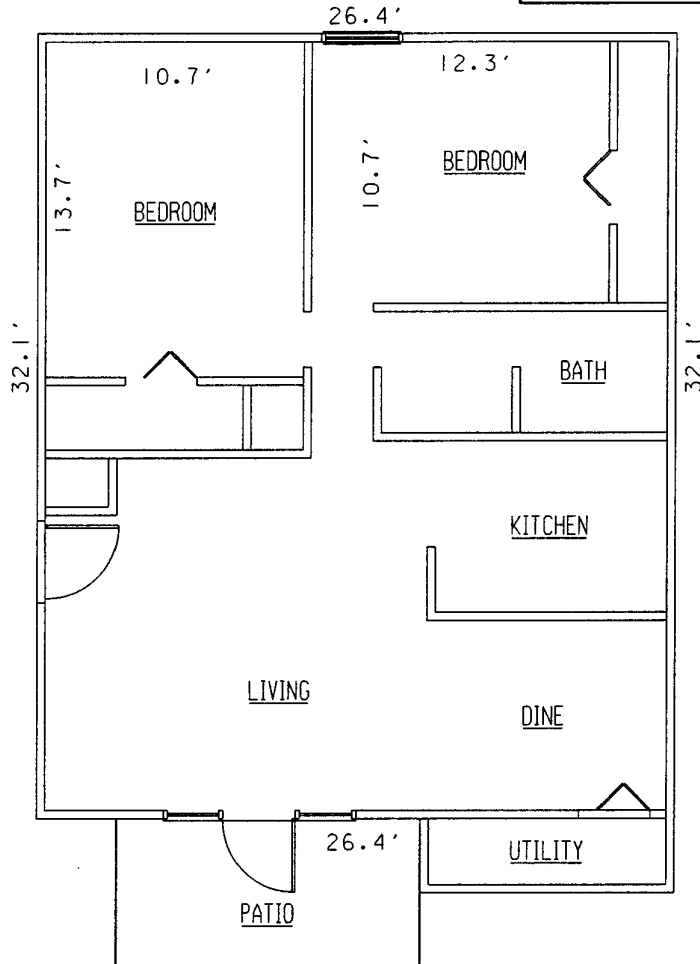

2 UNIT TYPE A2  
 2 BEDROOM FLOOR PLAN W/ PATIO

UNIT NUMBERS 601, 602, 603, 604, 605, 606, 607,  
 608, 701, 702, 703, 704, 705, 706, 707, 708, 801, 802, 803, 804,  
 805, 806, 807, 808, 901, 902, 903, 904, 905, 906, 907, 908,  
 1201, 1202, 1203, 1204, 1205, 1206, 1207, 1208, 1209, 1210, 1211, 1212

GROSS AREA

| DESCRIPTION                | SQUARE FEET |
|----------------------------|-------------|
| 2 BEDROOM W/ PATIO UNIT A2 |             |
| HVAC                       | 880 S.F.    |
| PATIO                      | 76 S.F.     |
| TOTAL S.F.                 | 956 S.F.    |

NOTES:

1. L.C.E. DENOTES LIMITED COMMON ELEMENT
2. S.F. DENOTES SQUARE FEET
3. INTERIOR UNIT MODIFICATION MAY CHANGE UNIT LAYOUT (i.e. DOORWAYS MOVED, CLOSET SIZE CHANGED, BATHROOM ENLARGED), HOWEVER OUTSIDE DIMENSIONS AND AREAS REMAIN THE SAME FOR UNIT TYPE.



Bessent, Hammack & Ruckman, Inc.  
 Engineers - Planners - Landscape Architects - Surveyors  
 1900 Corporate Square Boulevard  
 Jacksonville, Florida 32216  
 Phone (904) 721-2991 Fax (904) 725-0171  
 Certification Number LB 6739

EXHIBIT 'A'  
 SHEET 35 OF 41

AUGUST 26, 2005  
 SCALE 1" = 7.5'

**CONDOMINIUM DRAWINGS  
MONTEREY AT BEACH BOULEVARD,  
A CONDOMINIUM  
UNIT FLOOR PLAN**

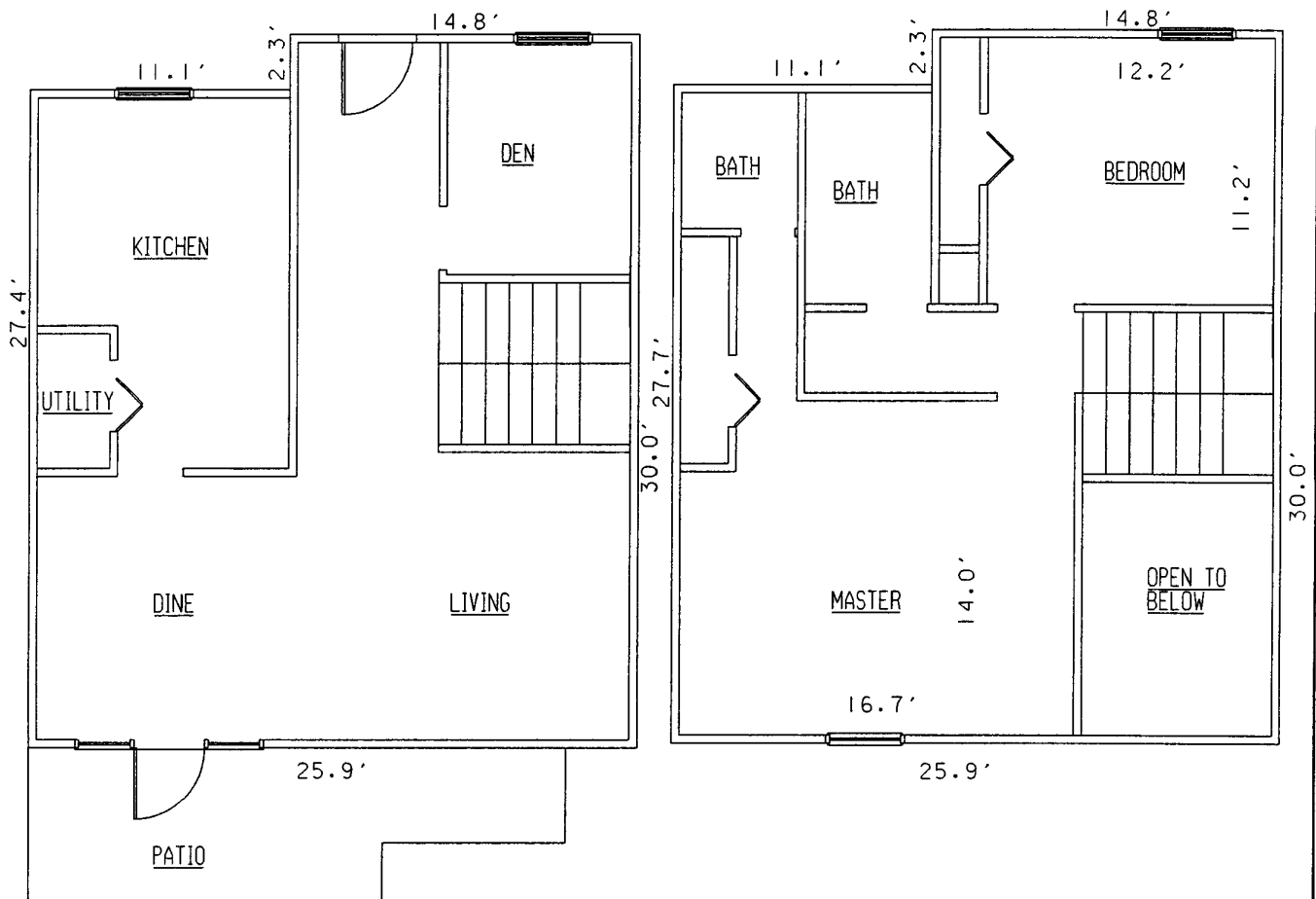

**FIRST FLOOR**

**SECOND FLOOR**

② UNIT TYPE T2 TOWNHOME  
2 BEDROOM FLOOR PLAN W/ PATIO

UNIT NUMBERS 1301, 1306, 1307.

**GROSS AREA**

| DESCRIPTION    | SQUARE FEET |
|----------------|-------------|
| 1st FLOOR HVAC | 750 S.F.    |
| 2nd FLOOR HVAC | 655 S.F.    |
| TOTAL HVAC     | 1,405 S.F.  |
| PATIO          | 130 S.F.    |
| TOTAL S.F.     | 1,535 S.F.  |

- NOTES:  
 1. L.C.E. DENOTES LIMITED COMMON ELEMENT  
 2. S.F. DENOTES SQUARE FEET  
 3. INTERIOR UNIT MODIFICATION MAY CHANGE UNIT LAYOUT  
 (I.e. DOORWAYS MOVED, CLOSET SIZE CHANGED, BATHROOM ENLARGED),  
 HOWEVER OUTSIDE DIMENSIONS AND AREAS REMAIN THE SAME FOR UNIT TYPE.



**Bessent, Hammack & Ruckman, Inc.**  
 Engineers - Planners - Landscape Architects - Surveyors  
 1900 Corporate Square Boulevard  
 Jacksonville, Florida 32216  
 Phone (904) 721-2991 Fax (904) 725-0171  
 Certification Number LB 6739

**EXHIBIT 'A'**  
SHEET 36 OF 41

AUGUST 26, 2005  
SCALE 1" = 7.5'

CONDOMINIUM DRAWINGS  
 MONTEREY AT BEACH BOULEVARD,  
 A CONDOMINIUM  
 UNIT FLOOR PLAN

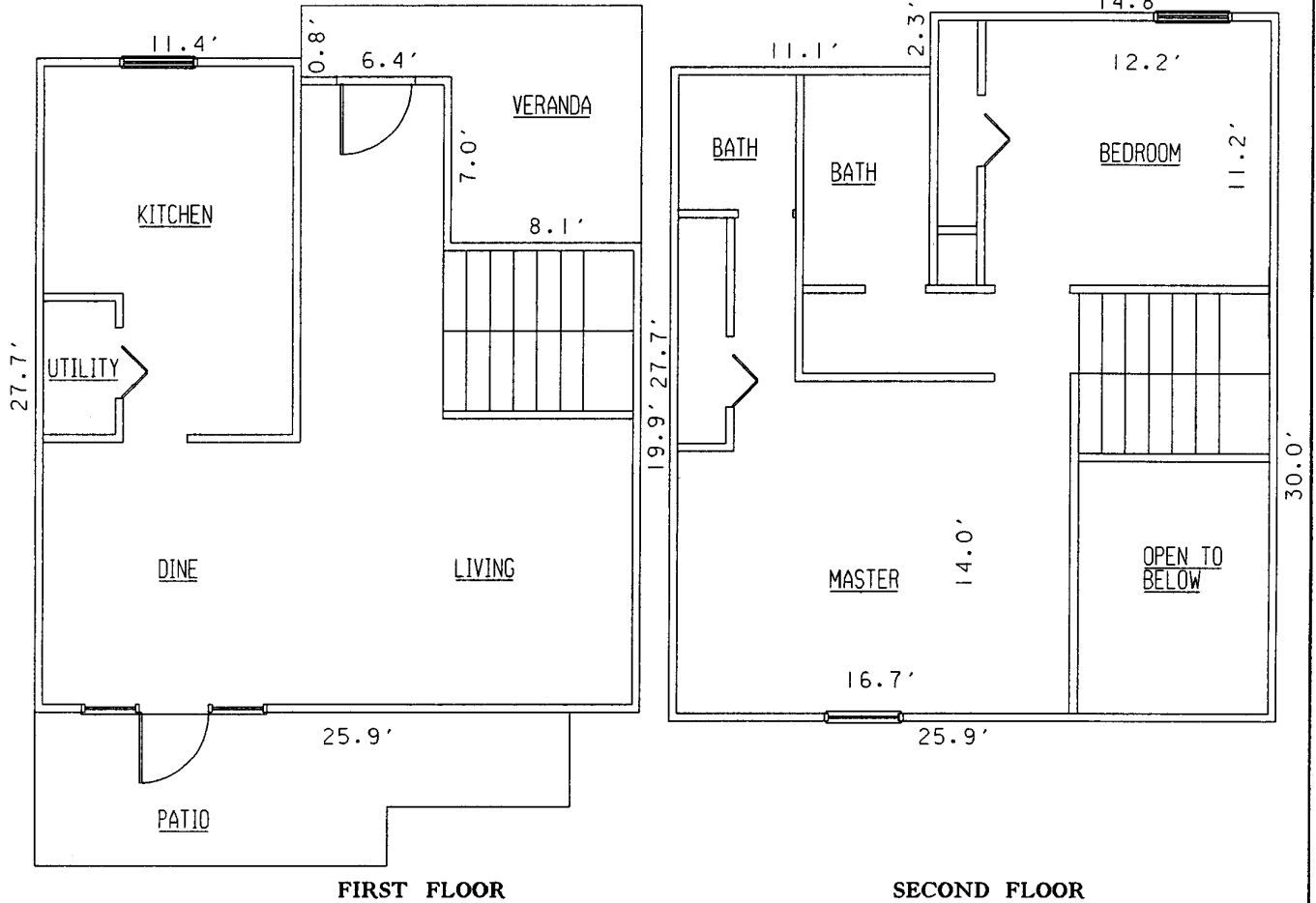

② UNIT TYPE V2 TOWNHOME  
 2 BEDROOM FLOOR PLAN W/ VERANDA

UNIT NUMBERS 1302, 1303, 1304, 1305.

GROSS AREA

| 2 BEDROOM W/ VERANDA UNIT V2 |             |
|------------------------------|-------------|
| DESCRIPTION                  | SQUARE FEET |
| 1st FLOOR HVAC               | 648 S.F.    |
| 2nd FLOOR HVAC               | 652 S.F.    |
| TOTAL HVAC                   | 1,300 S.F.  |
| PATIO                        | 230 S.F.    |
| TOTAL S.F.                   | 1,530 S.F.  |

- NOTES:
- L.C.E. DENOTES LIMITED COMMON ELEMENT
  - S.F. DENOTES SQUARE FEET
  - INTERIOR UNIT MODIFICATION MAY CHANGE UNIT LAYOUT (i.e. DOORWAYS MOVED, CLOSET SIZE CHANGED, BATHROOM ENLARGED), HOWEVER OUTSIDE DIMENSIONS AND AREAS REMAIN THE SAME FOR UNIT TYPE.



Bessent, Hammack & Ruckman, Inc.  
 Engineers - Planners - Landscape Architects - Surveyors  
 1900 Corporate Square Boulevard  
 Jacksonville, Florida 32216  
 Phone (904) 721-2991 Fax (904) 725-0171  
 Certification Number LB 6739

EXHIBIT 'A'  
 SHEET 37 OF 41

AUGUST 26, 2005  
 SCALE 1" = 7.5'

**CONDOMINIUM DRAWINGS  
MONTEREY AT BEACH BOULEVARD,  
A CONDOMINIUM  
UNIT FLOOR PLAN**

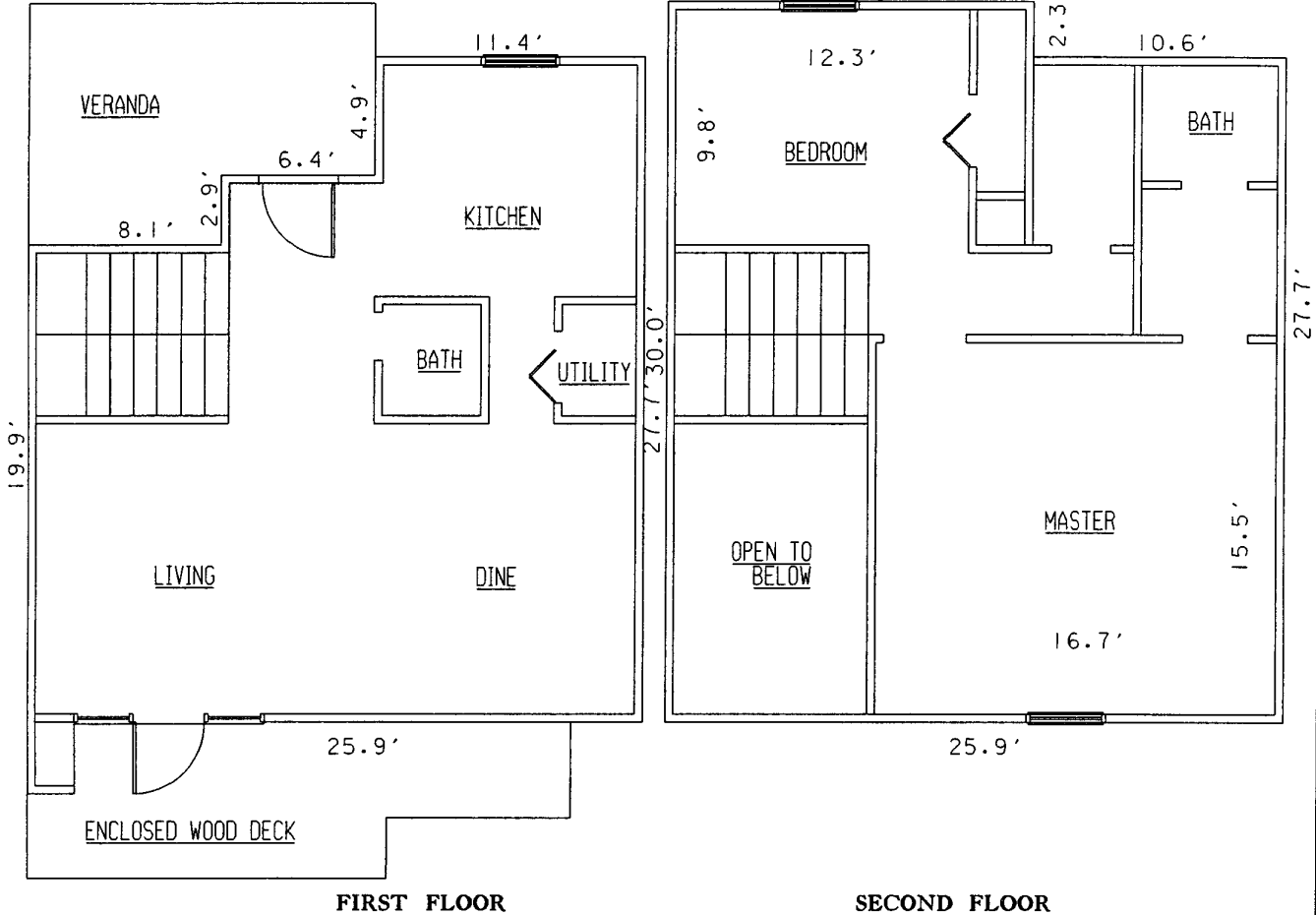

② UNIT TYPE D2 TOWNHOME  
2 BEDROOM FLOOR PLAN W/ DECK

**UNIT NUMBERS 101, 102, 103, 201, 202, 203, 204,  
205, 206, 301, 302, 303, 304, 305, 306, 307, 308,  
401, 402, 403, 404, 405, 406.**

**GROSS AREA**

| 2 BEDROOM W/ DECK | UNIT D2     |
|-------------------|-------------|
| DESCRIPTION       | SQUARE FEET |
| 1st FLOOR HVAC    | 618 S.F.    |
| 2nd FLOOR HVAC    | 642 S.F.    |
| TOTAL HVAC        | 1,260 S.F.  |
| ENCLOSED DECK     | 145 S.F.    |
| TOTAL S.F.        | 1,405 S.F.  |

- NOTES:  
 1. L.C.E. DENOTES LIMITED COMMON ELEMENT  
 2. S.F. DENOTES SQUARE FEET  
 3. INTERIOR UNIT MODIFICATION MAY CHANGE UNIT LAYOUT  
 (i.e. DOORWAYS MOVED, CLOSET SIZE CHANGED, BATHROOM ENLARGED),  
 HOWEVER OUTSIDE DIMENSIONS AND AREAS REMAIN THE SAME FOR UNIT TYPE.



**Bessent, Hammack & Ruckman, Inc.**  
 Engineers - Planners - Landscape Architects - Surveyors  
 1900 Corporate Square Boulevard  
 Jacksonville, Florida 32216  
 Phone (904) 721-2991 Fax (904) 725-0171  
 Certification Number LB 6739

**EXHIBIT 'A'**  
SHEET 38 OF 41

AUGUST 26, 2005  
SCALE 1" = 7.5'

CONDOMINIUM DRAWINGS  
 MONTEREY AT BEACH BOULEVARD,  
 A CONDOMINIUM  
 UNIT FLOOR PLAN

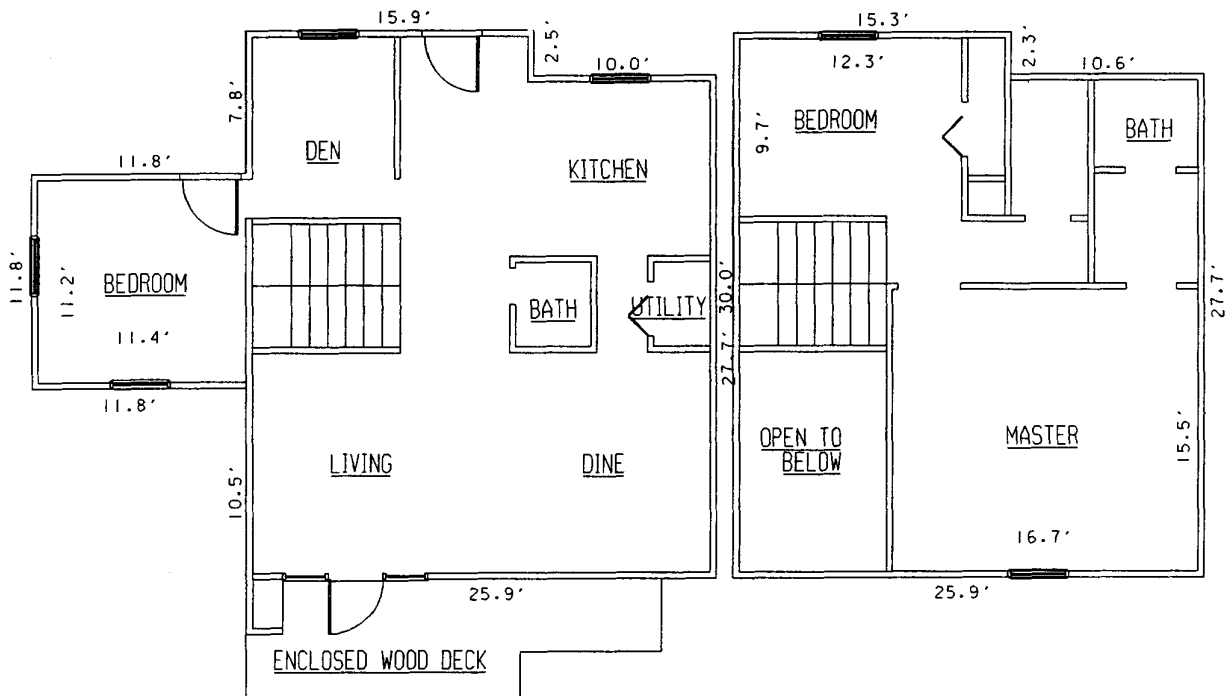

FIRST FLOOR

SECOND FLOOR

3 UNIT TYPE D3  
 3 BEDROOM FLOOR PLAN W/ DECK

UNIT NUMBER 104.

GROSS AREA

| 2 BEDROOM W/ DECK | UNIT D2     |
|-------------------|-------------|
| DESCRIPTION       | SQUARE FEET |
| 1st FLOOR HVAC    | 894 S.F.    |
| 2nd FLOOR HVAC    | 642 S.F.    |
| TOTAL HVAC        | 1,536 S.F.  |
| ENCLOSED DECK     | 145 S.F.    |
| TOTAL S.F.        | 1,681 S.F.  |

NOTES:  
 1. L.C.E. DENOTES LIMITED COMMON ELEMENT  
 2. S.F. DENOTES SQUARE FEET  
 3. INTERIOR UNIT MODIFICATION MAY CHANGE UNIT LAYOUT  
 (i.e. DOORWAYS MOVED, CLOSET SIZE CHANGED, BATHROOM ENLARGED),  
 HOWEVER OUTSIDE DIMENSIONS AND AREAS REMAIN THE SAME FOR UNIT TYPE.



Bessent, Hammack & Ruckman, Inc.  
 Engineers - Planners - Landscape Architects - Surveyors  
 1900 Corporate Square Boulevard  
 Jacksonville, Florida 32216  
 Phone (904) 721-2991 Fax (904) 725-0171  
 Certification Number LB 6739

EXHIBIT 'A'  
 SHEET 39 OF 41

AUGUST 26, 2005  
 SCALE 1" = 10'

REQ. NO. 05076.01

CONDOMINIUM DRAWINGS  
 MONTEREY AT BEACH BOULEVARD,  
 A CONDOMINIUM  
 ELEVATION PLAN

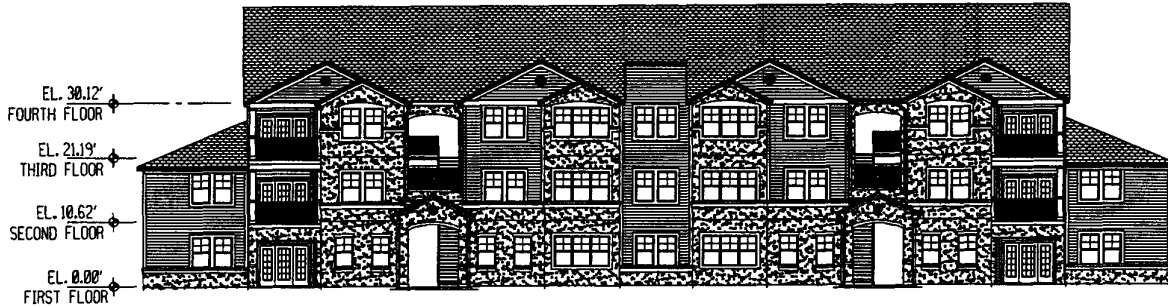

① BUILDING TYPE I - FRONT ELEVATION



② BUILDING TYPE I - SIDE ELEVATIONS



③ BUILDING TYPE I - REAR ELEVATION

LEGEND:

1. L.C.E. DENOTES LIMITED COMMON ELEMENT.
2. EL. DENOTES ELEVATION.
3. ELEVATIONSSHOWN HEREON BASED ON ASSUMED ELEVATION OF 0.00' AT THE FINISH FLOOR.



Bessent, Hammack & Ruckman, Inc.  
 Engineers - Planners - Landscape Architects - Surveyors  
 1900 Corporate Square Boulevard  
 Jacksonville, Florida 32216  
 Phone (904) 721-2991 Fax (904) 725-0171  
 Certification Number LB 6739

EXHIBIT 'A'  
 SHEET 40 OF 41

JUNE 29, 2005  
 SCALE 1" = 30'

CONDOMINIUM DRAWINGS  
 MONTEREY AT BEACH BOULEVARD,  
 A CONDOMINIUM  
 ELEVATION PLAN

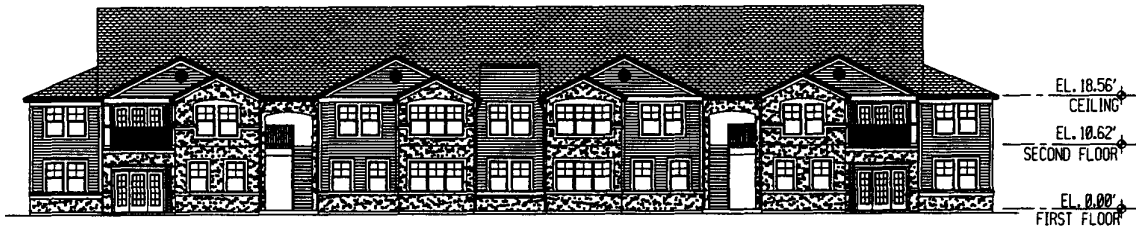

① BUILDING TYPE II - FRONT ELEVATION

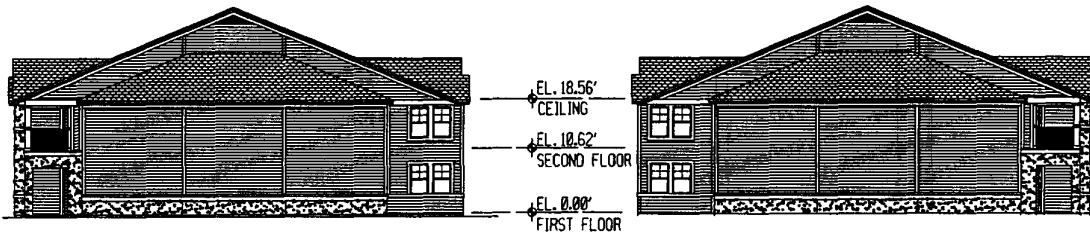

③ BUILDING TYPE II - RIGHT SIDE ELEVATION

② BUILDING TYPE II - LEFT SIDE ELEVATION



④ BUILDING TYPE II - REAR ELEVATION

LEGEND:

1. L.C.E. DENOTES LIMITED COMMON ELEMENT.
2. EL. DENOTES ELEVATION.
3. ELEVATIONSSHOWN HEREON BASED ON ASSUMED ELEVATION OF 0.00' AT THE FINISH FLOOR.



**Bessent, Hammack & Ruckman, Inc.**  
 Engineers - Planners - Landscape Architects - Surveyors  
 1900 Corporate Square Boulevard  
 Jacksonville, Florida 32216  
 Phone: (904) 721-2991 Fax: (904) 725-0171  
 Certification Number LB 6739

EXHIBIT 'A'  
 SHEET 41 OF 41

JUNE 29, 2005  
 SCALE 1" = 30'

**Exhibit "3"**  
**Schedule of Percentage Ownership**

| <u>Unit Type *</u> | <u>Number of Units</u> | <u>Sq. Ft.</u> | <u>Percentage Ownership of Common Elements</u> | <u>Bedrooms</u> | <u>Bathrooms</u> |
|--------------------|------------------------|----------------|--|-----------------|------------------|
| <u>A</u>           | 36                     | 600            | .2661%   | 1               | 1                |
| <u>B</u>           | 40                     | 880            | .3902%   | 2               | 1                |
| <u>C</u>           | 23                     | 1260           | .5587%   | 2               | 1.5              |
| <u>D</u>           | 4                      | 1300           | .5764%   | 2               | 2                |
| <u>E</u>           | 12                     | 833            | .3694%   | 1               | 1                |
| <u>F</u>           | 12                     | 965            | .4279%   | 1               | 1                |
| <u>G</u>           | 6                      | 1031           | .4572%   | 1               | 1                |
| <u>H</u>           | 6                      | 1163           | .5157%   | 1               | 1                |
| <u>I</u>           | 28                     | 1133           | .5024%   | 2               | 2                |
| <u>J</u>           | 28                     | 1265           | .5609%   | 2               | 2                |
| <u>K</u>           | 2                      | 1332           | .5906%   | 2               | 2                |
| <u>L</u>           | 2                      | 1464           | .6492%   | 2               | 2                |
| <u>M</u>           | 8                      | 1266           | .5614%   | 3               | 2                |
| <u>N</u>           | 8                      | 1398           | .6199%   | 3               | 2                |
| <u>O</u>           | 3                      | 1405           | .6230%   | 2               | 2                |
| <u>P</u>           | 1                      | 1536           | .6811%   | 3               | 2                |

**Building 1:**

| <u>Unit Type</u> | <u>Unit Nos.</u> |
|------------------|------------------|
| <u>A</u>         |                  |
| <u>B</u>         |                  |
| <u>C</u>         | 101, 102, 103    |
| <u>D</u>         |                  |
| <u>E</u>         |                  |
| <u>F</u>         |                  |
| <u>G</u>         |                  |
| <u>H</u>         |                  |
| <u>I</u>         |                  |
| <u>J</u>         |                  |
| <u>K</u>         |                  |
| <u>L</u>         |                  |



|          |     |
|----------|-----|
| <u>M</u> |     |
| <u>N</u> |     |
| <u>O</u> |     |
| <u>P</u> | 104 |

**Building 2:**

| <u>Unit Type</u> | <u>Unit Nos.</u>             |
|------------------|------------------------------|
| <u>A</u>         |                              |
| <u>B</u>         |                              |
| <u>C</u>         | 201, 202, 203, 204, 205, 206 |
| <u>D</u>         |                              |
| <u>E</u>         |                              |
| <u>F</u>         |                              |
| <u>G</u>         |                              |
| <u>H</u>         |                              |
| <u>I</u>         |                              |
| <u>J</u>         |                              |
| <u>K</u>         |                              |
| <u>L</u>         |                              |
| <u>M</u>         |                              |
| <u>N</u>         |                              |
| <u>O</u>         |                              |

**Building 3:**

| <u>Unit Type</u> | <u>Unit Nos.</u> |
|------------------|------------------|
| <u>A</u>         |                  |

|          |  |
|----------|--|
| <b>B</b> |  |
| <b>C</b> | 301, 302, 303, 304, 305, 306, 307, 308 |
| <b>D</b> |  |
| <b>E</b> |  |
| <b>F</b> |  |
| <b>G</b> |  |
| <b>H</b> |  |
| <b>I</b> |  |
| <b>J</b> |  |
| <b>K</b> |  |
| <b>L</b> |  |
| <b>M</b> |  |
| <b>N</b> |  |
| <b>O</b> |  |

**Building 4:**

| <b><u>Unit Type</u></b> | <b><u>Unit Nos.</u></b>      |
|-------------------------|------------------------------|
| <b>A</b>                |                              |
| <b>B</b>                |                              |
| <b>C</b>                | 401, 402, 403, 404, 405, 406 |
| <b>D</b>                |                              |
| <b>E</b>                |                              |

|   |  |
|---|--|
| F |  |
| G |  |
| H |  |
| I |  |
| J |  |
| K |  |
| L |  |
| M |  |
| N |  |
| O |  |

**Building 5:**

| <u>Unit Type</u> | <u>Unit Nos.</u>   |
|------------------|--|
| A                | 501, 502, 503, 504, 505, 506, 507, 508, 509, 510, 511, 512 |
| B                |  |
| C                |  |
| D                |  |
| E                |  |
| F                |  |
| G                |  |
| H                |  |
| I                |  |
| J                |  |
| K                |  |
| L                |  |
| M                |  |

|          |  |
|----------|--|
| <u>N</u> |  |
| <u>O</u> |  |

**Building 6:**

| <u>Unit Type</u> | <u>Unit Nos.</u>                       |
|------------------|--|
| A                |  |
| B                | 601, 602, 603, 604, 605, 606, 607, 608 |
| C                |  |
| D                |  |
| E                |  |
| F                |  |
| G                |  |
| H                |  |
| I                |  |
| J                |  |
| K                |  |
| L                |  |
| M                |  |
| N                |  |
| <u>O</u>         |  |

**Building 7:**

| <u>Unit Type</u> | <u>Unit Nos.</u>                       |
|------------------|--|
| A                |  |
| B                | 701, 702, 703, 704, 705, 706, 707, 708 |
| <u>C</u>         |  |

|   |  |
|---|--|
| D |  |
| E |  |
| F |  |
| G |  |
| H |  |
| I |  |
| J |  |
| K |  |
| L |  |
| M |  |
| N |  |
| O |  |

**Building 8:**

| <u>Unit Type</u> | <u>Unit Nos.</u>                       |
|------------------|--|
| A                |  |
| B                | 801, 802, 803, 804, 805, 806, 807, 808 |
| C                |  |
| D                |  |
| E                |  |
| F                |  |
| G                |  |
| H                |  |
| I                |  |
| J                |  |
| K                |  |

|          |  |
|----------|--|
| <b>L</b> |  |
| <b>M</b> |  |
| <b>N</b> |  |
| <b>O</b> |  |

**Building 9:**

| <b><u>Unit Type</u></b> | <b><u>Unit Nos.</u></b>                |
|-------------------------|--|
| <b>A</b>                |  |
| <b>B</b>                | 901, 902, 903, 904, 905, 906, 907, 908 |
| <b>C</b>                |  |
| <b>D</b>                |  |
| <b>E</b>                |  |
| <b>F</b>                |  |
| <b>G</b>                |  |
| <b>H</b>                |  |
| <b>I</b>                |  |
| <b>J</b>                |  |
| <b>K</b>                |  |
| <b>L</b>                |  |
| <b>M</b>                |  |
| <b>N</b>                |  |
| <b>O</b>                |  |

**Building 10:**

| <b><u>Unit Type</u></b> | <b><u>Unit Nos.</u></b>  |
|-------------------------|--|
| <b>A</b>                | 1001, 1002, 1003, 1004, 1005, 1006, 1007, 1008, 1009, 1010, 1011, 1012 |

|          |  |
|----------|--|
| <b>B</b> |  |
| <b>C</b> |  |
| <b>D</b> |  |
| <b>E</b> |  |
| <b>F</b> |  |
| <b>G</b> |  |
| <b>H</b> |  |
| <b>I</b> |  |
| <b>J</b> |  |
| <b>K</b> |  |
| <b>L</b> |  |
| <b>M</b> |  |
| <b>N</b> |  |
| <b>O</b> |  |

**Building 11:**

| <u>Unit Type</u> | <u>Unit Nos.</u>   |
|------------------|--|
| <b>A</b>         | 1101, 1102, 1103, 1104, 1105, 1106, 1107, 1108, 1109, 1110, 1111, 1112 |
| <b>B</b>         |  |
| <b>C</b>         |  |
| <b>D</b>         |  |
| <b>E</b>         |  |
| <b>F</b>         |  |
| <b>G</b>         |  |
| <b>H</b>         |  |
| <b>I</b>         |  |

|          |  |
|----------|--|
| <u>J</u> |  |
| <u>K</u> |  |
| <u>L</u> |  |
| <u>M</u> |  |
| <u>N</u> |  |
| <u>O</u> |  |

**Building 12:**

| <u>Unit Type</u> | <u>Unit Nos.</u>                               |
|------------------|--|
| <u>A</u>         | 1201, 1202, 1203, 1204, 1205, 1206, 1207, 1208 |
| <u>B</u>         |  |
| <u>C</u>         |  |
| <u>D</u>         |  |
| <u>E</u>         |  |
| <u>F</u>         |  |
| <u>G</u>         |  |
| <u>H</u>         |  |
| <u>I</u>         |  |
| <u>J</u>         |  |
| <u>K</u>         |  |
| <u>L</u>         |  |
| <u>M</u>         |  |
| <u>N</u>         |  |
| <u>O</u>         |  |

**Building 13:**



| <u>Unit Type</u> | <u>Unit Nos.</u>       |
|------------------|------------------------|
| A                |                        |
| B                |                        |
| C                |                        |
| D                | 1302, 1303, 1304, 1305 |
| E                |                        |
| F                |                        |
| G                |                        |
| H                |                        |
| I                |                        |
| J                |                        |
| K                |                        |
| L                |                        |
| M                |                        |
| N                |                        |
| O                | 1301, 1306, 1307       |

**Building 14:**

| <u>Unit Type</u> | <u>Unit Nos.</u> |
|------------------|------------------|
| A                |                  |
| B                |                  |
| C                |                  |
| D                |                  |
| E                | 1416, 1426       |
| F                | 1415, 1425,      |
| G                |                  |

|          |                                    |
|----------|------------------------------------|
| <b>H</b> |                                    |
| <b>I</b> |                                    |
| <b>J</b> | 1412, 1413, 1418, 1422, 1423, 1428 |
| <b>K</b> | 1411, 1414, 1417, 1421, 1424, 1427 |
| <b>L</b> |                                    |
| <b>M</b> |                                    |
| <b>N</b> |                                    |
| <b>O</b> |                                    |

**Building 15:**

| <b><u>Unit Type</u></b> | <b><u>Unit Nos.</u></b> |
|-------------------------|-------------------------|
| <b>A</b>                |                         |
| <b>B</b>                |                         |
| <b>C</b>                |                         |
| <b>D</b>                |                         |
| <b>E</b>                | 1516, 1526              |
| <b>F</b>                | 1515, 1525              |
| <b>G</b>                | 1531, 1536, 1537        |
| <b>H</b>                | 1532, 1535, 1538        |
| <b>I</b>                | 1514, 1524              |
| <b>J</b>                | 1513, 1523              |
| <b>K</b>                | 1534                    |
| <b>L</b>                | 1533                    |
| <b>M</b>                | 1511, 1517, 1521, 1527  |
| <b>N</b>                | 1512, 1518, 1522, 1528  |
| <b>O</b>                |                         |

**Building 16:**

| <u>Unit Type</u> | <u>Unit Nos.</u>       |
|------------------|------------------------|
| <b>A</b>         |                        |
| <b>B</b>         |                        |
| <b>C</b>         |                        |
| <b>D</b>         |                        |
| <b>E</b>         | 1616, 1626             |
| <b>F</b>         | 1615, 1625             |
| <b>G</b>         | 1631, 1636, 1637       |
| <b>H</b>         | 1632, 1635, 1638       |
| <b>I</b>         | 1614, 1624             |
| <b>J</b>         | 1613, 1623             |
| <b>K</b>         | 1634                   |
| <b>L</b>         | 1633                   |
| <b>M</b>         | 1611, 1617, 1621, 1627 |
| <b>N</b>         | 1612, 1618, 1622, 1628 |
| <b>O</b>         |                        |

**Building 17:**

| <u>Unit Type</u> | <u>Unit Nos.</u> |
|------------------|------------------|
| <b>A</b>         |                  |
| <b>B</b>         |                  |
| <b>C</b>         |                  |
| <b>D</b>         |                  |
| <b>E</b>         | 1716, 1726       |
| <b>F</b>         | 1715, 1725       |

|          |                                    |
|----------|------------------------------------|
| <b>G</b> |                                    |
| <b>H</b> |                                    |
| <b>I</b> | 1711, 1714, 1717, 1721, 1724, 1727 |
| <b>J</b> | 1712, 1713, 1718, 1722, 1723, 1728 |
| <b>K</b> |                                    |
| <b>L</b> |                                    |
| <b>M</b> |                                    |
| <b>N</b> |                                    |
| <b>O</b> |                                    |

**Building 18:**

| <b><u>Unit Type</u></b> | <b><u>Unit Nos.</u></b>            |
|-------------------------|------------------------------------|
| <b>A</b>                |                                    |
| <b>B</b>                |                                    |
| <b>C</b>                |                                    |
| <b>D</b>                |                                    |
| <b>E</b>                | 1816, 1826                         |
| <b>F</b>                | 1815, 1825                         |
| <b>G</b>                |                                    |
| <b>H</b>                |                                    |
| <b>I</b>                | 1811, 1814, 1817, 1821, 1824, 1827 |
| <b>J</b>                | 1812, 1813, 1818, 1822, 1823, 1828 |
| <b>K</b>                |                                    |
| <b>L</b>                |                                    |
| <b>M</b>                |                                    |
| <b>N</b>                |                                    |

|          |  |
|----------|--|
| <u>Q</u> |  |
|----------|--|

**Building 19:**

| <u>Unit Type</u> | <u>Unit Nos.</u>                   |
|------------------|------------------------------------|
| <u>A</u>         |                                    |
| <u>B</u>         |                                    |
| <u>C</u>         |                                    |
| <u>D</u>         |                                    |
| <u>E</u>         | 1916, 1926,                        |
| <u>F</u>         | 1915, 1925                         |
| <u>G</u>         |                                    |
| <u>H</u>         |                                    |
| <u>I</u>         | 1911, 1914, 1917, 1921, 1924, 1927 |
| <u>J</u>         | 1912, 1913, 1918, 1922, 1923, 1928 |
| <u>K</u>         |                                    |
| <u>L</u>         |                                    |
| <u>M</u>         |                                    |
| <u>N</u>         |                                    |
| <u>Q</u>         |                                    |

Exhibit "4"

**BY-LAWS  
OF**

**MONTEREY AT BEACH BOULEVARD CONDOMINIUM ASSOCIATION, INC.**

*A Corporation Not for Profit  
Under the Laws of the State of Florida*

1. **Identity.** These are the By-Laws of **MONTEREY AT BEACH BOULEVARD CONDOMINIUM ASSOCIATION, INC.** (the "Association"), a corporation not for profit incorporated under the laws of the State of Florida, and organized for the purposes set forth in its Articles of Incorporation.
  - 1.1 **Fiscal Year.** The fiscal year of the Association shall be the twelve month period commencing January 1st and terminating December 31<sup>st</sup> of each year.
  - 1.2 **Seal.** The seal of the Association shall bear the name of the corporation, the word "Florida", the words "Corporation Not for Profit", and the year of incorporation.
  
2. **Definitions.** For convenience, these By-Laws shall be referred to as the "By-Laws" and the Articles of Incorporation of the Association as the "Articles". The other terms used in these By-Laws shall have the same definitions and meanings as those set forth in the Declaration for **MONTEREY AT BEACH BOULEVARD, A CONDOMINIUM**, unless herein provided to the contrary, or unless the context otherwise requires.
  
3. **Members.**
  - 3.1 **Annual Meeting.** The annual members' meeting shall be held on the date, at the place and at the time determined by the Board of Directors from time to time, provided that there shall be an annual meeting every calendar year and, to the extent possible, no later than thirteen (13) months after the last preceding annual meeting. The purpose of the meeting shall be, except as provided herein to the contrary, to elect Directors, and to transact any other business authorized to be transacted by the members, or as stated in the notice of the meeting sent to Unit Owners in advance thereof. Unless changed by the Board of Directors, the first annual meeting shall be held in the month of December following the year in which the Declaration is filed.
  
  - 3.2 **Special Meetings.** Special members' meetings shall be held at such places as provided herein for annual meetings, and may be called by the President or by a majority of the Board of Directors of the Association, and must be called by the President or Secretary upon receipt of a written request from a majority of the members of the Association. The business conducted at a special meeting shall be limited to that stated in the notice of the meeting. Special meetings may also be called by Unit Owners in the manner provided for in the Act. Notwithstanding the foregoing: (i) as to special meetings regarding the adoption of the Condominium's estimated operating budget, reference should be made to Section 10.1 of these By-Laws; and (ii) as to special meetings regarding recall of Board members, reference should be made to Section 4.3 of these By-Laws.
  
  - 3.3 **Participation by Unit Owners.** Subject to the following and such further reasonable restrictions as may be adopted from time to time by the Board, Unit Owners shall have the right to speak at the annual and special meetings of the Unit Owners, committee meetings and Board meetings with reference to all designated agenda items. A Unit Owner does not have the right to speak with respect to items not specifically designated on the agenda, provided, however, that the Board may permit an Unit Owner to speak on such items in its discretion. Every Unit Owner who desires to speak at a meeting, may do so, provided that the Unit Owner has filed a written request with the Secretary of the Association not less than 24 hours prior to the scheduled time for commencement of the meeting. Unless waived by the chairman of the meeting (which may be done in the chairman's sole and absolute discretion and without being deemed to constitute a waiver as to any other subsequent speakers), all Unit Owners speaking at a meeting shall be limited to a maximum of three (3) minutes per speaker. Any Unit Owner may tape record or videotape a meeting, subject to the following and such further reasonable restrictions as may be adopted from time to time by the Board:
    - (a) The only audio and video equipment and devices which Unit Owners are authorized to utilize at any such meeting is equipment which does not produce distracting sound or light emissions;
    - (b) Audio and video equipment shall be assembled and placed in position in advance of the commencement of the meeting.
    - (c) Anyone videotaping or recording a meeting shall not be permitted to move about the meeting room in order to facilitate the recording; and

- (d) At least 24 hours prior written notice shall be given to the Secretary of the Association by any Unit Owner desiring to make an audio or video taping of the meeting.

3.4 Notice of Meeting; Waiver of Notice. Notice of a meeting of members (annual or special), stating the time and place and the purpose(s) for which the meeting is called, shall be given by the President or Secretary. A copy of the notice shall be posted at a conspicuous place on the Condominium Property. The notice of an annual or special meeting shall be hand delivered, electronically transmitted or sent by regular mail to each Unit Owner, unless the Unit Owner waives in writing the right to receive notice of the annual meeting by mail. The delivery or mailing shall be to the address of the member as last furnished to the Association by the Unit Owner. However, if a Unit is owned by more than one person, the Association shall provide notice, for meetings and all other purposes, to that one address initially identified for that purpose by the Developer and thereafter as one or more of the Owners of the Unit shall so advise the Association in writing, or if no address is given or if the Owners disagree, notice shall be sent to the address for the Owner as set forth on the deed of the Unit. The posting and mailing of the notice for either special or annual meetings, which notice shall incorporate an identification of agenda items, shall be effected not less than fourteen (14) continuous days, nor more than sixty (60) days, prior to the date of the meeting. The Board shall adopt by rule, and give notice to Unit Owners of, a specific location on the Condominium Property upon which all notices of members' meetings shall be posted. In lieu of or in addition to the physical posting of notice of any meeting of the Unit Owners on the Condominium Property, the Association may, by reasonable rule, adopt a procedure for conspicuously posting and repeatedly broadcasting the notice and the agenda on a closed-circuit cable television system serving the Association, if any. However, if broadcast notice is used in lieu of a notice posted physically on the Condominium Property, the notice and agenda must be broadcast at least four times every broadcast hour of each day that a posted notice is otherwise required. When broadcast notice is provided, the notice and agenda must be broadcast in a manner and for a sufficient continuous length of time so as to allow an average reader to observe the notice and read and comprehend the entire content of the notice and the agenda.

Notice of specific meetings may be waived before or after the meeting and the attendance of any member (or person authorized to vote for such member), either in person or by proxy, shall constitute such member's waiver of notice of such meeting, and waiver of any and all objections to the place of the meeting, the time of the meeting or the manner in which it has been called or convened, except when his (or his authorized representative's) attendance is for the express purpose of objecting at the beginning of the meeting to the transaction of business because the meeting is not lawfully called.

An officer of the Association, or the manager or other person providing notice of the meeting shall provide an affidavit or United States Postal Service certificate of mailing, to be included in the official records of the Association, affirming that notices of meetings were posted and mailed or hand delivered in accordance with this Section and Section 718.112(2)(d) of the Act, to each Unit Owner at the appropriate address for such Unit Owner. No other proof of notice of a meeting shall be required.

3.5 Quorum. A quorum at members' meetings shall be attained by the presence, either in person or by proxy (limited or general), of persons entitled to cast in excess of 30% of the votes of members entitled to vote at the subject meeting.

3.6 Voting.

(a) Number of Votes. Except as provided in Section 3.11 hereof, in any meeting of members, the Owners of each Unit shall be entitled to cast the number of votes designated for their Unit as set forth in the Articles. The vote of a Unit shall not be divisible.

(b) Majority Vote. The acts approved by a majority of the votes present in person or by proxy at a meeting at which a quorum shall have been attained shall be binding upon all Unit Owners for all purposes, except where otherwise provided by law, the Declaration, the Articles or these By-Laws. As used in these By-Laws, the Articles or the Declaration, the terms "majority of the Unit Owners" and "majority of the members" shall mean a majority of the votes entitled to be cast by the members and not a majority of the members themselves and shall further mean more than 50% of the then total authorized votes present in person or by proxy and voting at any meeting of the Unit Owners at which a quorum shall have been attained. Similarly, if some greater percentage of members is required herein or in the Declaration or Articles, it shall mean such greater percentage of the votes of members and not of the members themselves.

- (c) Voting Member. If a Unit is owned by one person, that person's right to vote shall be established by the roster of members. If a Unit is owned by more than one person, those persons (including husbands and wives) shall decide among themselves as to who shall cast the vote of the Unit. In the event that those persons cannot so decide, no vote shall be cast. A person casting a vote for a Unit shall be presumed to have the authority to do so unless the President or the Board of Directors is otherwise notified. If a Unit is owned by a corporation, the person entitled to cast the vote for the Unit shall be designated by a certificate signed by an appropriate officer of the corporation and filed with the Secretary of the Association. Such person need not be a Unit Owner. Those certificates shall be valid until revoked or until superseded by a subsequent certificate or until a change in the ownership of the Unit concerned. A certificate designating the person entitled to cast the vote for a Unit may be revoked by any record owner of an undivided interest in the Unit. If a certificate designating the person entitled to cast the vote for a Unit for which such certificate is required is not on file or has been revoked, the vote attributable to such Unit shall not be considered in determining whether a quorum is present, nor for any other purpose, and the total number of authorized votes in the Association shall be reduced accordingly until such certificate is filed.
- 3.7 Proxies. Votes to be cast at meetings of the Association membership may be cast in person or by proxy. Except as specifically provided herein, Unit Owners may not vote by general proxy, but may vote by limited proxies substantially conforming to the limited proxy form approved by the Division. Limited proxies shall be permitted to the extent permitted by the Act. No proxy, limited or general, shall be used in the election of Board members. General proxies may be used for other matters for which limited proxies are not required and may also be used in voting for nonsubstantive changes to items for which a limited proxy is required and given. A proxy may be made by any person entitled to vote, but shall only be valid for the specific meeting for which originally given and any lawful adjourned meetings thereof. In no event shall any proxy be valid for a period longer than 90 days after the date of the first meeting for which it was given. Every proxy shall be revocable at any time at the pleasure of the person executing it. A proxy must be in writing, signed by the person authorized to cast the vote for the Unit (as above described), name the person(s) voting by proxy and the person authorized to vote for such person(s) and filed with the Secretary before the appointed time of the meeting, or before the time to which the meeting is adjourned. Each proxy shall contain the date, time and place of the meeting for which it is given and, if a limited proxy, shall set forth the matters on which the proxy holder may vote and the manner in which the vote is to be cast. There shall be no limitation on the number of proxies which may be held by any person (including a designee of the Developer). If a proxy expressly provides, any proxy holder may appoint, in writing, a substitute to act in its place. If such provision is not made, substitution is not permitted.
- 3.8 Adjourned Meetings. If any proposed meeting cannot be organized because a quorum has not been attained, the members who are present, either in person or by proxy, may adjourn the meeting from time to time until a quorum is present, provided notice of the newly scheduled meeting is given in the manner required for the giving of notice of a meeting. Except as required above, proxies given for the adjourned meeting shall be valid for the newly scheduled meeting unless revoked for reasons other than the new date of the meeting.
- 3.9 Order of Business. If a quorum has been attained, the order of business at annual members' meetings, and, if applicable, at other members' meetings, shall be:
- (a) Collect all ballots not yet cast;
  - (b) Call to order by President;
  - (c) Appointment by the President of a chairman of the meeting (who need not be a member or a director);
  - (d) Appointment of inspectors of election;
  - (e) Counting of Ballots for Election of Directors;
  - (f) Proof of notice of the meeting or waiver of notice;
  - (g) Reading of minutes;
  - (h) Reports of officers;
  - (i) Reports of committees;



- (j) Unfinished business;
- (k) New business;
- (l) Adjournment.

Such order may be waived in whole or in part by direction of the chairman.

- 3.10 Minutes of Meeting. The minutes of all meetings of Unit Owners shall be kept in a book available for inspection by Unit Owners or their authorized representatives and Board members at any reasonable time. The Association shall retain these minutes for a period of not less than seven (7) years.
- 3.11 Action Without A Meeting. Anything to the contrary herein notwithstanding, to the extent lawful, any action required or which may be taken at any annual or special meeting of members, may be taken without a meeting, without prior notice and without a vote if a consent in writing, setting forth the action so taken, shall be signed by the members (or persons authorized to cast the vote of any such members as elsewhere herein set forth) having not less than the minimum number of votes that would be necessary to authorize or take such action at a meeting of members at which all members (or authorized persons) entitled to vote thereon were present and voted. In order to be effective, the action must be evidenced by one or more written consents describing the action taken, dated and signed by approving members having the requisite number of votes and entitled to vote on such action, and delivered to the Secretary of the Association, or other authorized agent of the Association. Written consent shall not be effective to take the corporate action referred to in the consent unless signed by members having the requisite number of votes necessary to authorize the action within sixty (60) days of the date of the earliest dated consent and delivered to the Association as aforesaid. Any written consent may be revoked prior to the date the Association receives the required number of consents to authorize the proposed action. A revocation is not effective unless in writing and until received by the Secretary of the Association, or other authorized agent of the Association. Within ten (10) days after obtaining such authorization by written consent, notice must be given to members who have not consented in writing. The notice shall fairly summarize the material features of the authorized action. A consent signed in accordance with the foregoing has the effect of a meeting vote and may be described as such in any document.

#### 4. Directors.

- 4.1 Membership. The affairs of the Association shall be governed by a Board of not less than three (3) nor more than nine (9) directors, the exact number to be determined in the first instance in the Articles, and, thereafter, except as provided herein, from time to time upon majority vote of the membership. Directors must be natural persons who are 18 years of age or older. Any person who has been convicted of any felony by any court of record in the United States and who has not had his or her right to vote restored pursuant to law in the jurisdiction of his or her residence is not eligible for Board membership (provided, however, that the validity of any Board action is not affected if it is later determined that a member of the Board is ineligible for Board membership due to having been convicted of a felony). Directors may not vote at Board meetings by proxy or by secret ballot.
- 4.2 Election of Directors. Election of Directors shall be held at the annual members' meeting, except as herein provided to the contrary. Not less than sixty (60) days prior to a scheduled election, the Association shall mail, deliver or electronically transmit to each Unit Owner entitled to vote, a first notice of the date of election. Any Unit Owner or other eligible person desiring to be a candidate for the Board shall give written notice to the Secretary of the Association not less than forty (40) days prior to the scheduled election. Together with the notice of meeting and agenda sent in accordance with Section 3.4 above, the Association shall then, mail, deliver or electronically transmit a second notice of the meeting, not less than fourteen (14) days prior to the date of the meeting, to all Unit Owners entitled to vote therein, together with a ballot which shall list all candidates. Upon request of a candidate, the Association shall include an information sheet, no larger than 8-1/2 inches by 11 inches furnished by the candidate, which must be furnished by the candidate to the Association not less than thirty five (35) days before the election, to be included with the mailing of the ballot, with the costs of mailing or delivery and copying to be borne by the Association. The Association is not liable for the contents of the information sheets prepared by the candidates. In order to reduce costs, the Association may print or duplicate the information sheets on both sides of the paper.

The election of directors shall be by written ballot or voting machine. Proxies shall in no event be used in electing the Board at general elections or to fill vacancies caused by resignation or otherwise, provided, however, that limited proxies may be used to fill a vacancy resulting from the

recall of a director, in the manner provided by the rules of the Division. Elections shall be decided by a plurality of those ballots and votes cast. There shall be no quorum requirement, however at least 20 percent of the eligible voters must cast a ballot in order to have a valid election of members of the Board. There shall be no cumulative voting.

Notwithstanding the provisions of this Section 4.2, an election is not required unless more candidates file notices of intent to run or are nominated than vacancies exist on the Board.

#### 4.3 Vacancies and Removal.

- (a) Except as to vacancies resulting from removal of Directors by members (as addressed in subsection (b) below), vacancies in the Board of Directors occurring between annual meetings of members shall be filled by a majority vote of the remaining Directors at any Board meeting (even if the remaining Directors constitute less than a quorum), provided that all vacancies in directorships to which Directors were appointed by the Developer pursuant to the provisions of paragraph 4.15 hereof shall be filled by the Developer without the necessity of any meeting.
- (b) Any Director elected by the members (other than the Developer) may be removed by concurrence of a majority of the voting interests of the members at a special meeting of members called for that purpose or by written agreement signed by a majority of all voting interests. The vacancy in the Board of Directors so created shall be filled by the members at a special meeting of the members called for such purpose, or by the Board of Directors, in the case of removal by a written agreement unless said agreement also designates a new Director to take the place of the one removed. The conveyance of all Units owned by a Director in the Condominium (other than appointees of the Developer or Directors who were not Unit Owners) shall constitute the resignation of such Director.
- (c) Anything to the contrary herein notwithstanding, until a majority of the Directors are elected by members other than the Developer of the Condominium, neither the first Directors of the Association, nor any Directors replacing them, nor any Directors named by the Developer, shall be subject to removal by members other than the Developer. The first Directors and Directors replacing them may be removed and replaced by the Developer without the necessity of any meeting.
- (d) If a vacancy on the Board of Directors results in the inability to obtain a quorum of directors in accordance with these By-Laws, and the remaining Directors fail to fill the vacancy by appointment of a Director in accordance with applicable law, then any Owner may apply to the Circuit Court within whose jurisdiction the Condominium lies for the appointment of a receiver to manage the affairs of the Association. At least thirty (30) days prior to applying to the Circuit Court, the Unit Owner shall mail to the Association and post in a conspicuous place on the Condominium Property a notice describing the intended action and giving the Association an opportunity to fill the vacancy(ies) in accordance with these By-Laws. If, during such time, the Association fails to fill the vacancy(ies), the Unit Owner may proceed with the petition. If a receiver is appointed, the Association shall be responsible for the salary of the receiver, court costs and attorneys' fees. The receiver shall have all powers and duties of a duly constituted Board of Directors, and shall serve until the Association fills the vacancy(ies) on the Board sufficient to constitute a quorum in accordance with these By-Laws.

4.4 Term. Except as provided herein to the contrary, the term of each Director's service shall extend until the next annual meeting of the members and subsequently until his successor is duly elected and has taken office, or until he is removed in the manner elsewhere provided. Notwithstanding the foregoing, any Director designated by the Developer shall serve at the pleasure of the Developer and may be removed and replaced by the Developer at any time.

4.5 Organizational Meeting. The organizational meeting of newly-elected or appointed Directors shall be held within ten (10) days of their election or appointment. The directors calling the organizational meeting shall give at least three (3) days advance notice thereof, stating the time and place of the meeting.

4.6 Meetings. Meetings of the Board of Directors may be held at such time and place as shall be determined, from time to time, by a majority of the Directors. Meetings of the Board of Directors may be held by telephone conference, with those Directors attending by telephone counted toward the quorum requirement, provided that a telephone speaker must be used so that the conversation of those Directors attending by telephone may be heard by the Directors and any Unit Owners attending such meeting in person. Notice of meetings shall be given to each Director, personally or by mail, telephone or telegraph, and shall be transmitted at least three (3) days prior to the

meeting. Meetings of the Board of Directors and any Committee thereof at which a quorum of the members of that Committee are present shall be open to all Unit Owners. Any Unit Owner may tape record or videotape meetings of the Board, in accordance with the rules of the Division. The right to attend such meetings includes the right to speak at such meetings with respect to all designated agenda items. The Association may adopt reasonable rules governing the frequency, duration and manner of Unit Owner statements. Adequate notice of such meetings, which notice shall specifically incorporate an identification of agenda items, shall be posted conspicuously on the Condominium Property at least forty-eight (48) continuous hours preceding the meeting, except in the event of an emergency. Any item not included on the notice may be taken up on an emergency basis by at least a majority plus one of the members of the Board. Such emergency action shall be noticed and ratified at the next regular meeting of the Board. Notwithstanding the foregoing, written notice of any meeting of the Board at which nonemergency special assessments, or at which amendment to rules regarding unit use will be proposed, discussed or approved, shall be mailed, delivered or electronically transmitted to all Unit Owners and posted conspicuously on the Condominium property not less than fourteen (14) continuous days prior to the meeting. Evidence of compliance with this fourteen (14) continuous day notice shall be made by an affidavit executed by the Secretary of the Association and filed among the official records of the Association. The Board shall adopt by rule, and give notice to Unit Owners of, a specific location on the Condominium Property upon which all notices of Board and/or Committee meetings shall be posted. In lieu of or in addition to the physical posting of notice of any meeting of the Board on the Condominium Property, the Association may, by reasonable rule, adopt a procedure for conspicuously posting and repeatedly broadcasting the notice and the agenda on a closed-circuit cable television system serving the Association, if any. However, if broadcast notice is used in lieu of a notice posted physically on the Condominium Property, the notice and agenda must be broadcast at least four times every broadcast hour of each day that a posted notice is otherwise required. When broadcast notice is provided, the notice and agenda must be broadcast in a manner and for a sufficient continuous length of time so as to allow an average reader to observe the notice and read and comprehend the entire content of the notice and the agenda. Special meetings of the Directors may be called by the President, and must be called by the President or Secretary at the written request of one-third (1/3) of the Directors or where required by the Act. A Director or member of a Committee of the Board of Directors may submit in writing his/her agreement or disagreement with any action taken at a meeting that such individual did not attend. This agreement or disagreement may not be used for the purposes of creating a quorum.

- 4.7 Waiver of Notice. Any Director may waive notice of a meeting before or after the meeting and that waiver shall be deemed equivalent to the due receipt by said Director of notice. Attendance by any Director at a meeting shall constitute a waiver of notice of such meeting, and a waiver of any and all objections to the place of the meeting, to the time of the meeting or the manner in which it has been called or convened, except when a Director states at the beginning of the meeting, or promptly upon arrival at the meeting, any objection to the transaction of affairs because the meeting is not lawfully called or convened.
- 4.8 Quorum. A quorum at Directors' meetings shall consist of a majority of the entire Board of Directors. The acts approved by a majority of those present at a meeting at which a quorum is present shall constitute the acts of the Board of Directors, except when approval by a greater number of Directors is specifically required by the Declaration, the Articles or these By-Laws.
- 4.9 Adjourned Meetings. If, at any proposed meeting of the Board of Directors, there is less than a quorum present, the majority of those present may adjourn the meeting from time to time until a quorum is present, provided notice of such newly scheduled meeting is given as required hereunder. At any newly scheduled meeting, any business that might have been transacted at the meeting as originally called may be transacted as long as notice of such business to be conducted at the rescheduled meeting is given, if required (e.g., with respect to budget adoption).
- 4.10 Joinder in Meeting by Approval of Minutes. The joinder of a Director in the action of a meeting by signing and concurring in the minutes of that meeting shall constitute the approval of that Director of the business conducted at the meeting, but such joinder shall not allow the applicable Director to be counted as being present for purposes of quorum.
- 4.11 Presiding Officer. The presiding officer at the Directors' meetings shall be the President (who may, however, designate any other Unit Owner to preside).
- 4.12 Order of Business. If a quorum has been attained, the order of business at Directors' meetings shall be:
- (a) Proof of due notice of meeting;
  - (b) Reading and disposal of any unapproved minutes;

- (c) Reports of officers and committees;
- (d) Election of officers;
- (e) Unfinished business;
- (f) New business;
- (g) Adjournment.

Such order may be waived in whole or in part by direction of the presiding officer.

- 4.13 Minutes of Meetings. The minutes of all meetings of the Board of Directors shall be kept in a book available for inspection by Unit Owners, or their authorized representatives, and Board members at any reasonable time. The Association shall retain these minutes for a period of not less than seven years.
- 4.14 Committees. The Board may by resolution also create Committees and appoint persons to such Committees and vest in such Committees such powers and responsibilities as the Board shall deem advisable.
- 4.15 Proviso. Notwithstanding anything to the contrary contained in this Section 4 or otherwise, the Board shall consist of three directors during the period that the Developer is entitled to appoint a majority of the Directors, as hereinafter provided. The Developer shall have the right to appoint all of the members of the Board of Directors until Unit Owners other than the Developer own fifteen (15%) percent or more of the Units in the Condominium. When Unit Owners other than the Developer own fifteen percent (15%) or more of the Units in the Condominium that will be operated ultimately by the Association, the Unit Owners other than the Developer shall be entitled to elect not less than one-third (1/3) of the members of the Board of Directors. Upon the election of such director(s), the Developer shall forward to the Division of Florida Land Sales, Condominiums and Mobile Homes the name and mailing address of the director(s) elected. Unit Owners other than the Developer are entitled to elect not less than a majority of the members of the Board of Directors: (a) three years after fifty (50%) percent of the Units that will be operated ultimately by the Association have been conveyed to purchasers; (b) three months after ninety (90%) percent of the Units that will be operated ultimately by the Association have been conveyed to purchasers; (c) when all of the Units that will be operated ultimately by the Association have been completed, some of them have been conveyed to purchasers, and none of the others are being offered for sale by the Developer in the ordinary course of business; (d) when some of the Units have been conveyed to purchasers, and none of the others are being constructed or offered for sale by the Developer in the ordinary course of business; or (e) seven (7) years after recordation of the Declaration, whichever occurs first. The Developer is entitled (but not obligated) to elect at least one (1) member of the Board of Directors as long as the Developer holds for sale in the ordinary course of business five percent (5%) of the Units that will be operated ultimately by the Association.

The Developer may transfer control of the Association to Unit Owners other than the Developer prior to such dates in its sole discretion by causing enough of its appointed Directors to resign, whereupon it shall be the affirmative obligation of Unit Owners other than the Developer to elect Directors and assume control of the Association. Provided at least sixty (60) days' notice of Developer's decision to cause its appointees to resign is given to Unit Owners, neither the Developer, nor such appointees, shall be liable in any manner in connection with such resignations even if the Unit Owners other than the Developer refuse or fail to assume control.

Within seventy-five (75) days after the Unit Owners other than the Developer are entitled to elect a member or members of the Board of Directors, or sooner if the Developer has elected to accelerate such event as aforesaid, the Association shall call, and give not less than sixty (60) days' notice of an election for the member or members of the Board of Directors. The notice may be given by any Unit Owner if the Association fails to do so.

At the time the Unit Owners other than the Developer elect a majority of the members of the Board of Directors of the Association, the Developer shall relinquish control of the Association and such Unit Owners shall accept control. At that time (except as to subparagraph (g), which may be ninety (90) days thereafter) Developer shall deliver to the Association, at Developer's expense, all property of the Unit Owners and of the Association held or controlled by the Developer, including, but not limited to, the following items, if applicable to the Condominium:

- (a) The original or a photocopy of the recorded Declaration of Condominium, and all amendments thereto. If a photocopy is provided, the Developer must certify by affidavit that it is a complete copy of the actual recorded Declaration.
- (b) A certified copy of the Articles of Incorporation of the Association.
- (c) A copy of the By-Laws of the Association.
- (d) The minute book, including all minutes, and other books and records of the Association.
- (e) Any rules and regulations which have been adopted.
- (f) Resignations of resigning officers and Board members who were appointed by the Developer.
- (g) The financial records, including financial statements of the association, and source documents from the incorporation of the Association through the date of the turnover. The records shall be audited for the period from the incorporation of the Association or from the period covered by the last audit, if applicable, by an independent certified public accountant. All financial statements shall be prepared in accordance with generally accepted accounting principles and shall be audited in accordance with generally accepted auditing standards as prescribed by the Florida Board of Accountancy. The accountant performing the audit shall examine to the extent necessary supporting documents and records, including the cash disbursements and related paid invoices to determine if expenditures were for Association purposes, and billings, cash receipts and related records to determine that the Developer was charged and paid the proper amounts of Assessments.
- (h) Association funds or the control thereof.
- (i) All tangible personal property that is the property of the Association or is or was represented by the Developer to be part of the Common Elements or is ostensibly part of the Common Elements, and an inventory of such property.
- (j) A copy of the plans and specifications utilized in the construction or remodeling of Improvements and the supplying of equipment, and for the construction and installation of all mechanical components serving the Improvements and the Condominium Property, with a certificate, in affidavit form, of an officer of the Developer or an architect or engineer authorized to practice in Florida, that such plans and specifications represent, to the best of their knowledge and belief, the actual plans and specifications utilized in the construction and improvement of the Condominium Property and the construction and installation of the mechanical components serving the Improvements and the Condominium Property.
- (k) A list of the names and addresses of all contractors, subcontractors and suppliers, of which Developer had knowledge at any time in the development of the Condominium, utilized in the construction or remodeling of the improvements and the landscaping of the Condominium and/or Association Property.
- (l) Insurance policies.
- (m) Copies of any Certificates of Occupancy which may have been issued for the Condominium Property.
- (n) Any other permits issued by governmental bodies applicable to the Condominium Property in force or issued within one (1) year prior to the date the Unit Owners take control of the Association.
- (o) All written warranties of contractors, subcontractors, suppliers and manufacturers, if any, that are still effective.
- (p) A roster of Unit Owners and their addresses and telephone numbers, if known, as shown on the Developer's records.
- (q) Leases of the Common Elements and other leases to which the Association is a party, if applicable.

- (r) Employment contracts or service contracts in which the Association is one of the contracting parties, or service contracts in which the Association or Unit Owners have an obligation or responsibility, directly or indirectly, to pay some or all of the fee or charge of the person or persons performing the service.
- (s) All other contracts to which the Association is a party.

5. Authority of the Board.

5.1 Powers and Duties. The Board of Directors shall have the powers and duties necessary for the administration of the affairs of the Condominium and may take all acts, through the proper officers of the Association, in executing such powers, except such acts which by law, the Declaration, the Articles or these By-Laws may not be delegated to the Board of Directors by the Unit Owners. Such powers and duties of the Board of Directors shall include, without limitation (except as limited elsewhere herein), the following:

- (a) Operating and maintaining all Common Elements and the Association Property.
- (b) Determining the expenses required for the operation of the Association and the Condominium.
- (c) Employing and dismissing the personnel necessary for the maintenance and operation of the Common Elements and the Association Property.
- (d) Adopting and amending rules and regulations concerning the details of the operation and use of the Condominium and Association Property, subject to a right of the Unit Owners to overrule the Board as provided in Section 14 hereof.
- (e) Maintaining bank accounts on behalf of the Association and designating the signatories required therefor.
- (f) Purchasing, leasing or otherwise acquiring title to, or an interest in, property in the name of the Association, or its designee, for the use and benefit of its members. The power to acquire personal property shall be exercised by the Board and the power to acquire real property shall be exercised as described herein and in the Declaration.
- (g) Purchasing, leasing or otherwise acquiring Units or other property, including, without limitation, Units at foreclosure or other judicial sales, all in the name of the Association, or its designee.
- (h) Selling, leasing, mortgaging or otherwise dealing with Units acquired, and subleasing Units leased, by the Association, or its designee.
- (i) Organizing corporations and appointing persons to act as designees of the Association in acquiring title to or leasing Units or other property.
- (j) Obtaining and reviewing insurance for the Condominium and Association Property.
- (k) Making repairs, additions and improvements to, or alterations of, Condominium Property and Association Property, and repairs to and restoration of Condominium and Association Property, in accordance with the provisions of the Declaration after damage or destruction by fire or other casualty, or as a result of condemnation or eminent domain proceedings or otherwise.
- (l) Enforcing obligations of the Unit Owners, allocating profits and expenses and taking such other actions as shall be deemed necessary and proper for the sound management of the Condominium.
- (m) Levying fines against appropriate Unit Owners for violations of the rules and regulations established by the Association to govern the conduct of such Unit Owners. No fine shall be levied except after giving reasonable notice and opportunity for a hearing to the affected Unit Owner and, if applicable, his tenant, licensee or invitee. The hearing must be held before a committee of other Unit Owners. If the committee does not agree with the fine, the fine may not be levied. No fine may exceed \$100.00 per violation, however, a fine may be levied on the basis of each day of a continuing violation with a single notice and opportunity for hearing, provided however, that no such fine shall in the aggregate exceed \$1,000.00. No fine shall become a lien upon a Unit.

- (n) Purchasing or leasing Units for use by resident superintendents and other similar persons or for the general use and enjoyment of the Unit Owners.
- (o) Borrowing money on behalf of the Association or the Condominium when required in connection with the operation, care, upkeep and maintenance of Common Elements (if the need for the funds is unanticipated) or the acquisition of real property, and granting mortgages on and/or security interests in Association owned property; provided, however, that the consent of the Owners of at least two-thirds (2/3rds) of the Units represented at a meeting at which a quorum has been attained in accordance with the provisions of these By-Laws shall be required for the borrowing of any sum which would cause the total outstanding indebtedness of the Association to exceed \$10,000.00. If any sum borrowed by the Board of Directors on behalf of the Condominium pursuant to the authority contained in this subparagraph 5.1(o) is not repaid by the Association, a Unit Owner who pays to the creditor such portion thereof as his interest in his Common Elements bears to the interest of all the Unit Owners in the Common Elements shall be entitled to obtain from the creditor a release of any judgment or other lien which said creditor shall have filed or shall have the right to file against, or which will affect, such Owner's Unit. Notwithstanding the foregoing, the restrictions on borrowing contained in this subparagraph 5.1(o) shall not apply if such indebtedness is entered into for the purpose of financing insurance premiums, which action may be undertaken solely by the Board of Directors, without requiring a vote of the Unit Owners.
- (p) Subject to the provisions of Section 5.2 below, contracting for the management and maintenance of the Condominium and Association Property and authorizing a management agent (who may be an affiliate of the Developer) to assist the Association in carrying out its powers and duties by performing such functions as the submission of proposals, collection of Assessments, preparation of records, enforcement of rules and maintenance, repair, and replacement of the Common Elements and Association Property with such funds as shall be made available by the Association for such purposes. The Association and its officers shall, however, retain at all times the powers and duties granted by the Declaration, the Articles, these By-Laws and the Act, including, but not limited to, the making of Assessments, promulgation of rules and execution of contracts on behalf of the Association.
- (q) At its discretion, but within the parameters of the Act, authorizing Unit Owners or other persons to use portions of the Common Elements or Association Property for private parties and gatherings and imposing reasonable charges for such private use.
- (r) Executing all documents or consents, on behalf of all Unit Owners (and their mortgagees), required by all governmental and/or quasi-governmental agencies in connection with land use and development matters (including, without limitation, plats, waivers of plat, unities of title, covenants in lieu thereof, etc.), and in that regard, each Owner, by acceptance of the deed to such Owner's Unit, and each mortgagee of a Unit Owner by acceptance of a lien on said Unit, appoints and designates the President of the Association as such Owner's agent and attorney-in-fact to execute any and all such documents or consents.
- (s) Exercising (i) all powers specifically set forth in the Declaration, the Articles, these By-Laws and in the Act, (ii) all powers incidental thereto, and (iii) all other powers of a Florida corporation not for profit.

5.2 Contracts. Any contract which is not to be fully performed within one (1) year from the making thereof, for the purchase, lease or renting of materials or equipment to be used by the Association in accomplishing its purposes, and all contracts for the provision of services, shall be in writing. Where a contract for purchase, lease or renting materials or equipment, or for the provision of services, requires payment by the Association on behalf of the Condominium in the aggregate exceeding \$5,000.00, the Association shall obtain competitive bids for the materials, equipment or services. Nothing contained herein shall be construed to require the Association to accept the lowest bid. Notwithstanding the foregoing, contracts with employees of the Association and contracts for attorney, accountant, architect, community association manager, engineering and landscape architect services shall not be subject to the provisions hereof. Further, nothing contained herein is intended to limit the ability of the Association to obtain needed products and services in an emergency; nor shall the provisions hereof apply if the business entity with which the Association desires to contract is the only source of supply within the County.

6. Officers.

- 6.1 Executive Officers. The executive officers of the Association shall be a President, a Vice-President, a Treasurer and a Secretary (none of whom need be Directors), all of whom shall be elected by the Board of Directors and who may be peremptorily removed at any meeting by concurrence of a majority of all of the Directors. A person may hold more than one office except the President may not also be the Secretary or the Vice-President, and the Secretary may not be the Treasurer. No person shall sign an instrument or perform an act in the capacity of more than one office. The Board of Directors from time to time shall elect such other officers and designate their powers and duties as the Board shall deem necessary or appropriate to manage the affairs of the Association. Officers, other than designees of the Developer, must be Unit Owners (or authorized representatives of corporate/partnership/trust Unit Owners).
- 6.2 President. The President shall be the chief executive officer of the Association. He shall have all of the powers and duties that are usually vested in the office of president of an association.
- 6.3 Vice-President. The Vice-President shall exercise the powers and perform the duties of the President in the absence or disability of the President. He also shall assist the President and exercise such other powers and perform such other duties as are incident to the office of the vice president of an association and as may be required by the Directors or the President.
- 6.4 Secretary. The Secretary shall keep the minutes of all proceedings of the Directors and the members. The Secretary shall attend to the giving of all notices to the members and Directors and other notices required by law. The Secretary shall have custody of the seal of the Association and shall affix it to instruments requiring the seal when duly signed. The Secretary shall keep the records of the Association, except those of the Treasurer, and shall perform all other duties incident to the office of the secretary of an association and as may be required by the Directors or the President.
- 6.5 Treasurer. The Treasurer shall have custody of all property of the Association, including funds, securities and evidences of indebtedness. The Treasurer shall keep books of account for the Association in accordance with good accounting practices, which, together with substantiating papers, shall be made available to the Board of Directors for examination at reasonable times. The Treasurer shall submit a treasurer's report to the Board of Directors at reasonable intervals and shall perform all other duties incident to the office of treasurer and as may be required by the Directors or the President. All monies and other valuable effects shall be kept for the benefit of the Association in such depositories as may be designated by a majority of the Board of Directors.
- 6.6 Developer Appointees. No officer appointed by the Developer may be removed except as provided in Section 4.15 hereof and by law.
7. Fiduciary Duty. The officers and directors of the Association, as well as any manager employed by the Association, have a fiduciary relationship to the Unit Owners. No officer, director or manager shall solicit, offer to accept, or accept any thing or service of value for which consideration has not been provided for his own benefit or that of his immediate family, from any person providing or proposing to provide goods or services to the Association. Any such officer, director or manager who knowingly so solicits, offers to accept or accepts any thing or service of value shall, in addition to all other rights and remedies of the Association and Unit Owners, be subject to a civil penalty in accordance with the Act. Notwithstanding the foregoing, this paragraph shall not prohibit an officer, director or manager from accepting services or items received in connection with trade fairs or education programs.
8. Compensation. Neither Directors nor officers shall receive compensation for their services as such, but this provision shall not preclude the Board of Directors from employing a Director or officer as an employee of the Association, nor preclude contracting with a Director or officer for the management of the Condominium or for any other service to be supplied by such Director or officer. Directors and officers shall be compensated for all actual and proper out of pocket expenses relating to the proper discharge of their respective duties.
9. Resignations. Any Director or officer may resign his post at any time by written resignation, delivered to the President or Secretary, which shall take effect upon its receipt unless a later date is specified in the resignation, in which event the resignation shall be effective from such date unless withdrawn. The acceptance of a resignation shall not be required to make it effective. The conveyance of all Units owned by any Director or officer (other than appointees of the Developer or officers who were not Unit Owners) shall constitute a written resignation of such Director or officer.
10. Fiscal Management. The provisions for fiscal management of the Association set forth in the Declaration and Articles shall be supplemented by the following provisions:



10.1 Budget.

(a) Adoption by Board; Items. The Board of Directors shall from time to time, and at least annually, prepare a budget for all Condominiums governed and operated by the Association (which shall detail all accounts and items of expense and contain at least all items set forth in Section 718.504(21) of the Act, if applicable), determine the amount of Assessments payable by the Unit Owners to meet the expenses of such Condominium(s) and allocate and assess such expenses among the Unit Owners in accordance with the provisions of the Declaration. In addition, if the Association maintains limited common elements with the cost to be shared only by those entitled to use the limited common elements, the budget or a schedule attached thereto shall show amounts budgeted therefor. In addition to annual operating expenses, the budget shall include reserve accounts for capital expenditures and deferred maintenance (to the extent required by law). These accounts shall include, but not be limited to, roof replacement, building painting and pavement resurfacing regardless of the amount of deferred maintenance expense or replacement cost, and for any other item for which the deferred maintenance expense or replacement cost exceeds \$10,000.00. The amount of reserves shall be computed by means of a formula which is based upon the estimated remaining useful life and the estimated replacement cost of each reserve item. The Association may adjust replacement and reserve assessments annually to take into account any changes in estimates or extension of the useful life of a reserve item caused by deferred maintenance. Reserves shall not be required if the members of the Association have, by a majority vote at a duly called meeting of members, determined for a specific fiscal year to provide no reserves or reserves less adequate than required hereby. Prior to transfer of control of the Association to Unit Owners other than the Developer, the Developer may vote to waive reserves or reduce the funding of reserves for the first two (2) fiscal years of operation of the Association, beginning with the fiscal year in which the Declaration is recorded, after which time and until transfer of control of the Association to Unit Owners other than the Developer, reserves may only be waived or reduced upon the vote of a majority of all non-Developer voting interests voting in person or by limited proxy at a duly called meeting of the Association. Following transfer of control of the Association to Unit Owners other than the Developer, the Developer may vote its voting interest to waive or reduce the funding of reserves. If a meeting of Unit Owners has been called to determine to provide no reserves or reserves less adequate than required, and such result is not attained or a quorum is not attained, the reserves, as included in the budget, shall go into effect. Reserve funds and any interest accruing thereon shall remain in the reserve account or accounts, and shall be used only for authorized reserve expenditures, unless their use for any other purposes is approved in advance by a majority vote at a duly called meeting of the Association. Prior to transfer of control of the Association to Unit Owners other than the Developer, the Association shall not vote to use reserves for purposes other than that for which they were intended without the approval of a majority of all non-Developer voting interests, voting in person or by limited proxy at a duly called meeting of the Association.

The adoption of a budget for the Condominium shall comply with the requirements hereinafter set forth:

- (i) Notice of Meeting. A copy of the proposed budget of Common Expenses shall be hand delivered, mailed or electronically transmitted to each Unit Owner (at the address last furnished to the Association) not less than fourteen (14) days prior to the meeting of the Board of Directors at which the budget will be considered, together with a notice of that meeting indicating the time and place of such meeting. An officer or manager of the Association, or other person providing notice of such meeting, shall execute an affidavit evidencing compliance with such notice requirement and such affidavit shall be filed among the official records of the Association.
- (ii) Special Membership Meeting. If the Board of Directors adopts in any fiscal year an annual budget which requires assessments against Unit Owners which exceed one hundred fifteen percent (115%) of such Assessments for the preceding fiscal year, the Board of Directors shall conduct a special meeting of the Unit Owners to consider a substitute budget if the Board of Directors receives, within twenty-one (21) days following the adoption of the annual budget, a written request for a special meeting from at least ten percent (10%) of all voting interests. The special meeting shall be conducted within sixty (60) days following the adoption of the annual budget. At least fourteen (14) days prior to such special meeting, the Board of Directors shall hand deliver to each Unit Owner, or mail to each Unit Owner at the address last furnished to the Association, a notice of the meeting. An officer or manager of the Association, or other person providing notice of such meeting, shall execute an affidavit evidencing compliance with this notice requirement and such affidavit shall be filed among the official records of the Association. Unit Owners may consider and adopt a substitute budget at the special meeting. A substitute budget is adopted if approved by a majority of all voting interests. If there is not a quorum at the special meeting or a substitute budget is not adopted, the annual budget previously adopted by the Board of Directors shall take effect as scheduled.
- (iii) Determination of Budget Amount. Any determination of whether assessments exceed one hundred fifteen percent (115%) of assessments for the preceding fiscal year shall

exclude any authorized provision for reasonable reserves for repair or replacement of the Condominium Property, anticipated expenses of the Association which the Board of Directors does not expect to be incurred on a regular or annual basis, or assessments for betterments to the Condominium Property.

- (iv) Proviso. As long as the Developer is in control of the Board of Directors of the Association, the Board shall not impose Assessments for a year greater than one hundred fifteen percent (115%) of the prior fiscal year's Assessments, as herein defined, without the approval of a majority of all voting interests.

(b) Adoption by Membership. In the event that the Board of Directors shall be unable to adopt a budget for a fiscal year in accordance with the requirements of Subsection 10.1(a) above, the Board of Directors may call a special meeting of Unit Owners for the purpose of considering and adopting such budget, which meeting shall be called and held in the manner provided for such special meetings in said subsection, or propose a budget in writing to the members, and if such budget is adopted by the members, upon ratification by a majority of the Board of Directors, it shall become the budget for such year.

- 10.2 Assessments. Assessments against Unit Owners for their share of the items of the budget shall be made for the applicable fiscal year annually at least twenty (20) days preceding the year for which the Assessments are made. Such Assessments shall be due in equal installments, payable in advance on the first day of each month (or each quarter at the election of the Board) of the year for which the Assessments are made. If annual Assessments are not made as required, Assessments shall be presumed to have been made in the amount of the last prior Assessments, and monthly (or quarterly) installments on such Assessments shall be due upon each installment payment date until changed by amended Assessments. In the event the annual Assessments prove to be insufficient, the budget and Assessments may be amended at any time by the Board of Directors, subject to the provisions of Section 10.1 hereof, if applicable. Unpaid Assessments for the remaining portion of the fiscal year for which amended Assessments are made shall be payable in as many equal installments as there are full months (or quarters) of the fiscal year left as of the date of such amended Assessments, each such monthly (or quarterly) installment to be paid on the first day of the month (or quarter), commencing the first day of the next ensuing month (or quarter). If only a partial month (or quarter) remains, the amended Assessments shall be paid with the next regular installment in the following year, unless otherwise directed by the Board in its resolution.
- 10.3 Special Assessments and Assessments for Capital Improvements. Special Assessments and Capital Improvement Assessments (as defined in the Declaration) shall be levied as provided in the Declaration and shall be paid in such manner as the Board of Directors of the Association may require in the notice of such Assessments. The funds collected pursuant to a Special Assessment shall be used only for the specific purpose or purposes set forth in the notice of adoption of same. However, upon completion of such specific purpose or purposes, any excess funds will be considered Common Surplus, and may, at the discretion of the Board, either be returned to the Unit Owners or applied as a credit towards future assessments.
- 10.4 Depository. The depository of the Association shall be such bank or banks in the State of Florida, which bank or banks must be insured by the FDIC, as shall be designated from time to time by the Directors and in which the monies of the Association shall be deposited. Withdrawal of monies from those accounts shall be made only by checks signed by such person or persons as are authorized by the Directors. All sums collected by the Association from Assessments or otherwise may be commingled in a single fund or divided into more than one fund, as determined by a majority of the Board of Directors. In addition, a separate reserve account should be established for the Association in such a depository for monies specifically designated as reserves for capital expenditures and/or deferred maintenance. Reserve and operating funds of the Association shall not be commingled unless combined for investment purposes, provided that the funds so commingled shall be accounted for separately and the combined account balance of such commingled funds may not, at any time, be less than the amount identified as reserve funds in the combined account.
- 10.5 Acceleration of Installments Upon Default. If a Unit Owner shall be in default in the payment of an installment upon his Assessments, the Board of Directors or its agent may accelerate the balance of the current budget years' Assessments upon thirty (30) days' prior written notice to the Unit Owner and the filing of a claim of lien, and the then unpaid balance of the current budget years' Assessments shall be due upon the date stated in the notice, but not less than five (5) days after delivery of the notice to the Unit Owner, or not less than ten (10) days after the mailing of such notice to him by certified mail, whichever shall first occur.
- 10.6 Fidelity Insurance or Fidelity Bonds. The Association shall obtain and maintain adequate insurance or fidelity bonding of all persons who control or disburse Association funds, which shall include, without limitation, those individuals authorized to sign Association checks and the

president, secretary and treasurer of the Association. The insurance policy or fidelity bond shall be in such amount as shall be determined by a majority of the Board, but must be sufficient to cover the maximum funds that will be in the custody of the Association or its management agent at any one time. The premiums on such bonds and/or insurance shall be paid by the Association as a Common Expense

- 10.7 Accounting Records and Reports. The Association shall maintain accounting records in the State, according to accounting practices normally used by similar associations. The records shall be open to inspection by Unit Owners or their authorized representatives at reasonable times and written summaries of them shall be supplied at least annually. The records shall include, but not be limited to, (a) a record of all receipts and expenditures, and (b) an account for each Unit designating the name and current mailing address of the Unit Owner, the amount of Assessments, the dates and amounts in which the Assessments come due, the amount paid upon the account and the dates so paid, and the balance due. Written summaries of the records described in clause (a) above, in the form and manner specified below, shall be supplied to each Unit Owner annually.

Within ninety (90) days following the end of the fiscal year, the Association shall prepare and complete, or contract for the preparation and completion of a financial report for the preceding fiscal year (the "Financial Report"). Within twenty-one (21) days after the final Financial Report is completed by the Association, or received from a third party, but not later than one hundred twenty (120) days following the end of the fiscal year, the Board shall mail, or furnish by personal delivery, a copy of the Financial Report to each Unit Owner, or a notice that a copy of the Financial Report will be mailed or hand delivered to the Unit Owner, without charge, upon receipt of a written request from the Unit Owner.

The Financial Report shall be prepared in accordance with the rules adopted by the Division. The type of Financial Report to be prepared shall, unless modified in the manner set forth below, be based upon the Association's total annual revenues, as follows:

- (a) REPORT OF CASH RECEIPTS AND EXPENDITURES – if the Association's revenues are less than \$100,000.00 or if the Association operates less than fifty (50) Units (regardless of revenue) [or, if determined by the Board, the Association may prepare any of the reports described in subsections (b), (c) or (d) below in lieu of the report described in this section (a)].
- (b) COMPILED FINANCIAL STATEMENTS – if the Association's revenues are equal to or greater than \$100,000.00, but less than \$200,000.00 [or, if determined by the Board, the Association may prepare any of the reports described in subsections (c) or (d) below in lieu of the report described in this section (b)].
- (c) REVIEWED FINANCIAL STATEMENTS – if the Association's revenues are equal to or greater than \$200,000.00, but less than \$400,000.00 [or, if determined by the Board, the Association may prepare the report described in subsection (d) below in lieu of the report described in this section (c)].
- (d) AUDITED FINANCIAL STATEMENTS – if the Association's revenues are equal to or exceed \$400,000.00.

A report of cash receipts and expenditures must disclose the amount of receipts by accounts and receipt classifications and the amount of expenses by accounts and expense classifications, including, but not limited to, the following, as applicable: costs for security, professional and management fees and expenses, taxes, costs for recreation facilities, expenses for refuse collection and utility services, expenses for lawn care, costs for building maintenance and repair, insurance costs, administration and salary expenses, and reserves accumulated and expended for capital expenditures, deferred maintenance, and any other category for which the association maintains reserves.

If approved by a majority of the voting interests present at a properly called meeting of the Association, the Association may prepare or cause to be prepared: (i) a report of cash receipts and expenditures in lieu of a compiled, reviewed, or audited financial statement; (ii) a report of cash receipts and expenditures or a compiled financial statement in lieu of a reviewed or audited financial statement; or (iii) a report of cash receipts and expenditures, a compiled financial statement or a reviewed financial statement in lieu of an audited financial statement. Such meeting and approval must occur prior to the end of the fiscal year and is effective only for the fiscal year in which the vote is taken. Prior to the time that control of the Association has been turned over to Unit Owners other than the Developer, all Unit Owners, including the Developer, may vote on issues related to the preparation of financial reports for the first two (2) fiscal years of the Association's operation. Thereafter, until control of the Association has been turned over

to Unit Owners other than the Developer, all Unit Owners except for the Developer may vote on such issues.

- 10.8 Application of Payment. All payments made by a Unit Owner shall be applied as provided in these By-Laws and in the Declaration or as otherwise determined by the Board.
- 10.9 Notice of Meetings. Notice of any meeting where Assessments against Unit Owners are to be considered for any reason shall specifically contain a statement that Assessments will be considered and the nature of any such Assessments.
11. Roster of Unit Owners. Each Unit Owner shall file with the Association a copy of the deed or other document showing his ownership. The Association shall maintain such information. The Association may rely upon the accuracy of such information for all purposes until notified in writing of changes therein as provided above. Only Unit Owners of record on the date notice of any meeting requiring their vote is given shall be entitled to notice of and to vote at such meeting, unless prior to such meeting other Owners shall produce adequate evidence, as provided above, of their interest and shall waive in writing notice of such meeting.
12. Parliamentary Rules. Except when specifically or impliedly waived by the chairman of a meeting (either of members or directors), Robert's Rules of Order (latest edition) shall govern the conduct of the Association meetings when not in conflict with the Act, the Declaration, the Articles or these By-Laws; provided, however, that a strict or technical reading of said Robert's Rules shall not be made so as to frustrate the will of the persons properly participating in said meeting.
13. Amendments. Except as may be provided in the Declaration to the contrary, these By-Laws may be amended in the following manner:
- 13.1 Notice. Notice of the subject matter of a proposed amendment shall be included in the notice of a meeting at which a proposed amendment is to be considered.
- 13.2 Adoption. A resolution for the adoption of a proposed amendment may be proposed either by a majority of the Board of Directors or by not less than one-third (1/3) of the members of the Association. Directors and members not present in person or by proxy at the meeting considering the amendment may express their approval in writing, provided that such approval is delivered to the Secretary at or prior to the meeting. The approval must be:
- (a) by not less than a majority of the votes of all members of the Association represented at a meeting at which a quorum has been attained and by not less than 66-2/3% of the entire Board of Directors; or
  - (b) after control of the Association has been turned over to Unit Owners other than the Developer, by not less than 80% of the votes of the members of the Association represented at a meeting at which a quorum has been attained.
- 13.3 Proviso. No amendment may be adopted which would eliminate, modify, prejudice, abridge or otherwise adversely affect any rights, benefits, privileges or priorities granted or reserved to the Developer or mortgagees of Units without the consent of said Developer and mortgagees in each instance. No amendment shall be made that is in conflict with the Articles or Declaration. No amendment to this Section shall be valid.
- 13.4 Execution and Recording. A copy of each amendment shall be attached to a certificate certifying that the amendment was duly adopted as an amendment of these By-Laws, which certificate shall be executed by the President or Vice-President and attested by the Secretary or Assistant Secretary of the Association with the formalities of a deed, or by the Developer alone if the amendment has been adopted consistent with the provisions of the Declaration allowing such action by the Developer. The amendment shall be effective when the certificate and a copy of the amendment is recorded in the Public Records of the County with an identification on the first page of the amendment of the Official Records Book and Page of said Public Records where the Declaration is recorded.
14. Rules and Regulations. Attached hereto as **Schedule "A"** and made a part hereof are initial rules and regulations concerning the use of portions of the Condominium and Association Property. The Board of Directors may, from time to time, modify, amend or add to such rules and regulations, except that subsequent to the date control of the Board is turned over by the Developer to Unit Owners other than the Developer, Owners of a majority of the Units may overrule the Board with respect to any such modifications, amendments or additions. Copies of such modified, amended or additional rules and regulations shall be furnished by the Board of Directors to each affected Unit Owner not less than thirty

(30) days prior to the effective date thereof. At no time may any rule or regulation be adopted which would prejudice the rights reserved to the Developer.

15. Official Records. From the inception of the Association, the Association shall maintain for the condominium, a copy of each of the following, where applicable, which shall constitute the official records of the Association:
- (a) The plans, permits, warranties, and other items provided by the Developer pursuant to Section 718.301(4) of the Act;
  - (b) A photocopy of the recorded Declaration of Condominium and all amendments thereto;
  - (c) A photocopy of the recorded By-Laws of the Association and all amendments thereto;
  - (d) A certified copy of the Articles of Incorporation of the Association or other documents creating the Association and all amendments thereto;
  - (e) A copy of the current Rules and Regulations of the Association;
  - (f) A book or books containing the minutes of all meetings of the Association, of the Board of Directors, and of Unit Owners, which minutes shall be retained for a period of not less than 7 years.
  - (g) A current roster of all Unit Owners, their mailing addresses, Unit identifications, voting certifications, and if known, telephone numbers. The Association shall also maintain the electronic mailing addresses and the numbers designated by Unit Owners for receiving notices sent by electronic transmission of those Unit Owners consenting to receive notice by electronic transmission. The electronic mailing addresses and numbers provided by Unit Owners to receive notice by electronic transmission shall be removed from Association records when consent to receive notice by electronic transmission is revoked. However, the Association shall not be liable for an erroneous disclosure of the electronic mail address or the number for receiving electronic transmission of notices;
  - (h) All current insurance policies of the Association and of all Condominiums operated by the Association;
  - (i) A current copy of any management agreement, lease, or other contract to which the Association is a party or under which the Association or the Unit Owners have an obligation or responsibility;
  - (j) Bills of Sale or transfer for all property owned by the Association;
  - (k) Accounting records for the Association and the accounting records for the Condominium. All accounting records shall be maintained for a period of not less than 7 years. The accounting records shall include, but not be limited to:
    - (i) Accurate, itemized, and detailed records for all receipts and expenditures.
    - (ii) A current account and a monthly, bimonthly, or quarterly statement of the account for each Unit designating the name of the Unit Owner, the due date and amount of each Assessment, the amount paid upon the account, and the balance due.
    - (iii) All audits, reviews, accounting statements, and financial reports of the Association or Condominium.
    - (iv) All contracts for work to be performed. Bids for work to be performed shall also be considered official records and shall be maintained for a period of 1 year;
  - (l) Ballots, sign-in sheets, voting proxies and all other papers relating to elections which shall be maintained for a period of 1 year from the date of the meeting to which the document relates.
  - (m) All rental records where the Association is acting as agent for the rental of Units.
  - (n) A copy of the current Question and Answer Sheet, in the form promulgated by the Division, which shall be updated annually.
  - (o) All other records of the Association not specifically listed above which are related to the operation of the Association.

The official records of the Association shall be maintained in the County in which the Condominium is located, or if in another county, then within twenty five (25) miles of the Condominium.

The official records of the Association shall be open to inspection by any Association member or the authorized representative of such member and shall be made available to a Unit Owner within five (5) working days after receipt of a written request by the board or its designees. The right to inspect the records includes the right to make or obtain copies, at a reasonable expense, if any, of the Association member. The Association may adopt reasonable rules regarding the time, location, notice and manner of record inspections and copying. The failure of an Association to provide official records to a Unit Owner or his authorized representative within ten (10) working days after receipt of a written request therefor shall create a rebuttable presumption that the Association willfully failed to comply with this paragraph. Failure to permit inspection of the Association records as provided herein entitles any person prevailing in an enforcement action to recover reasonable attorneys' fees from the person in control of the records who, directly or indirectly, knowingly denies access to the records for inspection. The Association shall maintain on the Condominium Property an adequate number of copies of the Declaration, Articles, By-Laws and rules, and all amendments to the foregoing, as well as the Question and Answer Sheet and year-end financial information required by the Act, to ensure their availability to Unit Owners and prospective purchasers. The Association may charge its actual costs for preparing and furnishing these documents to those persons requesting same. Notwithstanding the provisions of this Section 15, the following records shall not be accessible to Unit Owners:

- (i) Any record protected by the lawyer-client privilege as described in Section 90.502, Florida Statutes, and any record protected by the work-product privilege including any record prepared by an Association attorney or prepared at the attorney's express direction, which reflects a mental impression, conclusion, litigation strategy, or legal theory of the attorney or the Association, and which was prepared exclusively for civil or criminal litigation or for adversarial administrative proceedings, or which was prepared in anticipation or imminent civil or criminal litigation or imminent adversarial administrative proceedings until the conclusion of the litigation or adversarial administrative proceedings.
  - (ii) Information obtained by an Association in connection with the approval of the lease, sale or other transfer of a Unit.
  - (iii) Medical records of Unit Owners.
16. Certificate of Compliance. A certificate of compliance from a licensed electrical contractor or electrician may be accepted by the Association's Board as evidence of compliance of the Units to the applicable condominium fire and life safety code.
  17. Provision of Information to Purchasers or Lienholders. The Association or its authorized agent shall not be required to provide a prospective purchaser or lienholder with information about the Condominium or the Association other than information or documents required by the Act to be made available or disclosed. The Association or its authorized agent shall be entitled to charge a reasonable fee to the prospective purchaser, lienholder, or the current Unit Owner for its time in providing good faith responses to requests for information by or on behalf of a prospective purchaser or lienholder, other than that required by law, provided that such fee shall not exceed \$150.00 plus the reasonable cost of photocopying and any attorney's fees incurred by the Association in connection with the Association's response.
  18. Electronic Transmission. For purposes hereof, "electronic transmission" means any form of communication, not directly involving the physical transmission or transfer of paper, which creates a record that may be retained, retrieved, and reviewed by a recipient thereof and which may be directly reproduced in a comprehensible and legible paper form by such recipient through an automated process. Examples of electronic transmission include, but are not limited to, telegrams, facsimile transmissions of images, and text that is sent via electronic mail between computers. Notwithstanding the provision for electronic transmission of notices by the Association, same may be only be sent to Unit Owners that consent to receipt of Association notices by electronic transmission (and only for long as such consent remains in effect). Further, in no event may electronic transmission be used as a method of giving notice of a meeting called in whole or in part regarding the recall of a Director.
  19. Construction. Wherever the context so permits, the singular shall include the plural, the plural shall include the singular, and the use of any gender shall be deemed to include all genders.
  20. Captions. The captions herein are inserted only as a matter of convenience and for reference, and in no way define or limit the scope of these By-Laws or the intent of any provision hereof.
  21. Arbitration. In the event that there are internal disputes among Members, the Association or their agents and assigns arising from or in connection with the operation of the Condominium, the parties shall enter

into mandatory non-binding arbitration pursuant to the rules and regulations of the Division in accordance with Section 718.1255, Florida Statutes.

The foregoing was adopted as the By-Laws of **MONTEREY AT BEACH BOULEVARD CONDOMINIUM ASSOCIATION, INC.**, a corporation not for profit under the laws of the State of Florida, as of the 16 day of February, 2007.

Approved:

  
\_\_\_\_\_  
SCOTT ACKER, President

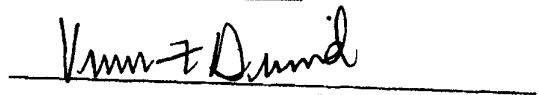
  
\_\_\_\_\_  
, Secretary

**SCHEDULE "A"**  
**TO**  
**BY-LAWS**

**RULES AND REGULATIONS**  
**FOR**

**MONTEREY AT BEACH BOULEVARD CONDOMINIUM ASSOCIATION, INC.**

1. The sidewalks, entrances, passages, lobbies and hallways and like portions of the Common Elements shall not be obstructed nor used for any purpose other than for ingress and egress to and from the Condominium Property; nor shall any carts, grills, bicycles, carriages, chairs, tables or any other objects be stored therein, except in areas (if any) designated for such purposes.
2. The personal property of Unit Owners and occupants must be stored in their respective Units.
3. No articles other than patio-type furniture shall be placed on the balconies, patios, terraces or lanais or other Common Elements or Limited Common Elements. No linens, cloths, clothing, bathing suits or swimwear, curtains, rugs, mops, or laundry of any kind, or other articles, shall be shaken or hung from any of the windows, doors, balconies, patios, terraces, lanais or other portions of the Condominium or Association Property. To the extent permitted by law, no charcoal or propane grills shall be placed and/or used on the balconies, patios, terraces, lanais or other Common or Limited Common Elements.
4. No Unit Owner or occupant shall permit anything to fall from a window or door of the Condominium or Association Property, nor sweep or throw from the Condominium or Association Property any dirt or other substance onto any of the balconies, patios, terraces, lanais or elsewhere in the Building or upon the Common Elements.
5. No garbage, refuse, trash or rubbish shall be deposited except as permitted by the Association. The requirements from time to time of the company or agency providing trash removal services for disposal or collection shall be complied with. All equipment for storage or disposal of such material shall be kept in a clean and sanitary condition.
6. No Unit Owner or occupant shall make or permit any disturbing noises by himself or his family, servants, employees, pets, agents, visitors or licensees, nor permit any conduct by such persons or pets that will interfere with the rights, comforts or conveniences of other Unit Owners or occupants. No Unit Owner or occupant shall play or permit to be played any musical instrument, nor operate or permit to be operated a phonograph, television, radio or sound amplifier in his Unit in such a manner as to disturb or annoy other residents. No Unit Owner or occupant shall conduct, nor permit to be conducted, vocal or instrumental instruction at any time which disturbs other residents.
7. No sign, advertisement, notice or other graphics or lettering shall be exhibited, displayed, inscribed, painted or affixed in, on or upon any part of the Condominium or Association Property, except signs used or approved by the Developer (for as long as the Developer owns any portion of the Condominium Property, and thereafter by the Board). Additionally, no awning, canopy, shutter or other projection shall be attached to or placed upon the outside walls or roof of the Building or on the Common Elements, without the prior written consent of the Board of Directors of the Association.
8. No flammable, combustible or explosive fluids, chemicals or substances shall be kept in any Unit or on the Common Elements.
9. A Unit Owner or occupant who plans to be absent during the hurricane season must prepare his Unit prior to his departure by designating a responsible firm or individual to care for his Unit should a hurricane threaten the Unit or should the Unit suffer hurricane damage, and furnishing the Association with the name(s) of such firm or individual. Such firm or individual shall be subject to the approval of the Association.
10. A Unit Owner or occupant shall not cause anything to be affixed or attached to, hung, displayed or placed on the exterior walls, doors, balconies or windows of the Building. Notwithstanding the foregoing, any Unit Owner may display one portable United States flag in a respectful way, and, on Armed Forces Day, memorial Day, Flag Day, Independence Day and Veterans Day, may display in a respectful way portable, removable official flags, not larger than 4 1/2 feet by 6 feet, that represent the United States Army, Navy, Air Force, Marine Corps or Coast Guard. Curtains and drapes (or linings thereof) which face on exterior windows or glass doors of Units shall be subject to disapproval by the Board, in which case they shall be removed and replaced with acceptable items.
11. Installation of satellite dishes by Unit Owners shall be restricted in accordance with the following: (i) installation shall be limited solely to the Unit or any Limited Common Elements appurtenant thereto, and may not be on the Common Elements; (ii) the dish may be no greater than one meter in diameter, and (iii) to the extent that same may be accomplished without (a) impairing reception of an acceptable quality signal, (b) unreasonably preventing or delaying installation, maintenance or use of an antenna, or (c) unreasonably increasing the cost of installing, maintaining or using an antenna, the dish shall be placed in a location which minimizes its visibility from the Common Elements.
12. No oil drilling, oil development operations, oil refining, quarrying or mining operations of any kind shall be permitted on, upon or in the Condominium or Association Property, nor shall oil wells, tanks, tunnels, mineral excavations or shafts be permitted upon or in the Condominium or Association Property. No derrick or



other structure designed for use in boring for oil, natural gas or minerals shall be erected, maintained or permitted upon any portion of the Condominium or Association Property.

13. No window air-conditioning units may be installed by Unit Owners or occupants. No Unit shall have any aluminum foil placed in any window or glass door or any reflective or tinted substance placed on any glass, unless approved, in advance by the Board of Directors in writing. No unsightly materials may be placed on any window or glass door or be visible through such window or glass door.

14. Children will be the direct responsibility of their parents or legal guardians, including full supervision of them while within the Condominium Property and including full compliance by them with these Rules and Regulations and all other rules and regulations of the Association. Loud noises will not be tolerated. All children under twelve (12) years of age must be accompanied by a responsible adult when entering and/or utilizing the recreational facilities.

15. Pets, birds, fish and other animals, reptiles or wildlife shall neither be kept nor maintained in or about the Condominium Property except in accordance with the following, in addition to the applicable terms of the Declaration:

- (a) Dogs or cats shall not be permitted outside of their owner's Unit unless attended by an adult and on a leash not more than six (6) feet long. Said dogs and cats shall only be walked or taken upon those portions of the Common Elements designated by the Association from time to time for such purposes. In no event shall said dog or cat ever be allowed to be walked or taken on or about any recreational facilities contained within the Condominium.
- (b) Fish or caged domestic (household-type) birds may be kept in the Units, subject to the provisions of the Declaration.
- (c) Unit owners shall pick up all solid wastes from their pets and dispose of same appropriately.

16. Every Owner and occupant shall comply with these Rules and Regulations as set forth herein, any and all rules and regulations which from time to time may be adopted, and the provisions of the Declaration, By-Laws and Articles of Incorporation of the Association, as amended from time to time. Failure of an Owner or occupant to so comply shall be grounds for action which may include, without limitation, an action to recover sums due for damages, injunctive relief, or any combination thereof. In addition to all other remedies, in the sole discretion of the Board of Directors of the Association, a fine or fines may be imposed upon an Owner for failure of an Owner, his family, guests, invitees, lessees or employees, to comply with any covenant, restriction, rule or regulation herein or in the Declaration, Articles of Incorporation or By-Laws, provided that the procedures set forth in the Declaration are adhered to. Fines shall not be construed to be an exclusive remedy and shall exist in addition to all other rights and remedies to which the Association may be otherwise legally entitled; however, any penalty paid by the offending Owner or occupant shall be deducted from or offset against any damages which the Association may otherwise be entitled to recover by law from such Owner or occupant.

17. These rules and regulations shall be cumulative with the covenants, conditions and restrictions set forth in the Declaration of Condominium, provided that the provisions of same shall control over these rules and regulations in the event of a conflict or a doubt as to whether a specific practice or activity is or is not permitted. Further, anything to the contrary notwithstanding, these rules and regulations shall not apply to the Developer, nor its agents or employees and contractors, nor to the Units owned by the Developer, except:

- (a) Requirements that leases or lessees be approved by the Association (if applicable); and
- (b) Restrictions on the presence of pets; and
- (c) Restrictions on occupancy of Units based upon age (if any); and
- (d) Restrictions on the type of vehicles allowed to park on Condominium Property; however, the Developer or its designees shall be exempt from any such parking restriction if the vehicle is engaged in any activity relating to construction, maintenance, or marketing of Units.

All of these rules and regulations shall apply to all other Owners and occupants even if not specifically so stated in portions hereof. The Board of Directors shall be permitted (but not required) to grant relief to one or more Unit Owners from specific rules and regulations upon written request therefor and good cause shown in the sole opinion of the Board.

Exhibit "5"

**ARTICLES OF INCORPORATION  
OF  
MONTEREY AT BEACH BOULEVARD CONDOMINIUM ASSOCIATION, INC.**

The undersigned incorporator, desiring to form a corporation not for profit under Chapter 617, Florida Statutes, as amended, hereby adopts the following Articles of Incorporation:

**ARTICLE 1**  
**NAME**

The name of the corporation shall be **MONTEREY AT BEACH BOULEVARD CONDOMINIUM ASSOCIATION, INC.**, which is hereinafter referred to as the "Association".

**ARTICLE 2**  
**OFFICE**

The principal office and mailing address of the Association shall be at 12171 Beach Boulevard, Jacksonville, FL 32246 or at such other place as may be subsequently designated by the Board of Directors. All books and records of the Association shall be kept at its principal office.

**ARTICLE 3**  
**PURPOSES AND POWERS**

The purpose for which the Association is organized is to provide an entity pursuant to the Florida Condominium Act as it exists on the date hereof (the "Act") for the operation of that certain condominium located in Duval County, Florida, and known as **MONTEREY AT BEACH BOULEVARD, A CONDOMINIUM** (the "Condominium").

**ARTICLE 4**  
**DEFINITIONS**

The terms used in these Articles shall have the same definitions and meanings as those set forth in the Declaration of the Condominium to be recorded in the Public Records of Duval County, Florida, unless herein provided to the contrary, or unless the context otherwise requires.

**ARTICLE 5**  
**POWERS**

The powers of the Association shall include and be governed by the following:

- 5.1 General. The Association shall have all of the common-law and statutory powers of a corporation not for profit under the Laws of Florida, except as expressly limited or restricted by the terms of these Articles, the Declaration, the By-Laws or the Act.
- 5.2 Enumeration. The Association shall have all of the powers and duties set forth in the Act, except as limited by these Articles, the By-Laws and the Declaration (to the extent that they are not in conflict with the Act), and all of the powers and duties reasonably necessary to operate the Condominium pursuant to the Declaration and as more particularly described in the By-Laws, as they may be amended from time to time, including, but not limited to, the following:
  - (a) To make and collect Assessments and other charges against members as Unit Owners (whether or not such sums are due and payable to the Association), and to use the proceeds thereof in the exercise of its powers and duties.
  - (b) To buy, accept, own, operate, lease, sell, trade and mortgage both real and personal property in accordance with the provisions of the Declaration.
  - (c) To maintain, repair, replace, reconstruct, add to and operate the Condominium Property and/or Association Property, and other property acquired or leased by the Association.
  - (d) To purchase insurance upon the Condominium Property and Association Property and insurance for the protection of the Association, its officers, directors and Unit Owners.
  - (e) To make and amend reasonable rules and regulations for the maintenance, conservation and use of the Condominium Property and Association Property and for the health, comfort, safety and welfare of the Unit Owners.

- (f) To approve or disapprove the leasing, transfer, ownership and possession of Units as may be provided by the Declaration.
  - (g) To enforce by legal means the provisions of the Act, the Declaration, these Articles, the By-Laws, and the rules and regulations for the use of the Condominium Property and Association Property.
  - (h) To contract for the management and maintenance of the Condominium Property and/or Association Property and to authorize a management agent (which may be an affiliate of the Developer) to assist the Association in carrying out its powers and duties by performing such functions as the submission of proposals, collection of Assessments, preparation of records, enforcement of rules and maintenance, repair and replacement of the Common Elements and Association Property with such funds as shall be made available by the Association for such purposes. The Association and its officers shall, however, retain at all times the powers and duties granted by the Condominium Act, including, but not limited to, the making of Assessments, promulgation of rules and execution of contracts on behalf of the Association.
  - (i) To employ personnel to perform the services required for the proper operation of the Condominium and the Association Property.
  - (j) To execute all documents or consents, on behalf of all Unit Owners (and their mortgagees), required by all governmental and/or quasi-governmental agencies in connection with land use and development matters (including, without limitation, plats, waivers of plat, unities of title, covenants in lieu thereof, etc.), and in that regard, each Unit Owner, by acceptance of the deed to such Owner's Unit, and each mortgagee of a Unit by acceptance of a lien on said Unit, appoints and designates the President of the Association as such Unit Owner's and mortgagee's agent and attorney-in-fact to execute, any and all such documents or consents.
- 5.3 Association Property. All funds and the title to all properties acquired by the Association and their proceeds shall be held for the benefit and use of the members in accordance with the provisions of the Declaration, these Articles and the By-Laws.
- 5.4 Distribution of Income; Dissolution. The Association shall not pay a dividend to its members and shall make no distribution of income to its members, directors or officers, and upon dissolution, all assets of the Association shall be transferred only to another non-profit corporation or a public agency or as otherwise authorized by the Florida Not For Profit Corporation Act (Chapter 617, Florida Statutes).
- 5.5 Limitation. The powers of the Association shall be subject to and shall be exercised in accordance with the provisions hereof and of the Declaration, the By-Laws and the Act, provided that in the event of conflict, the provisions of the Act shall control over those of the Declaration and By-Laws.

## ARTICLE 6 MEMBERS

- 6.1 Membership. The members of the Association shall consist of all of the record title owners of Units in the Condominium from time to time, and after termination of the Condominium, shall also consist of those who were members at the time of such termination, and their successors and assigns. In the event that a Unit is owned by a legal entity (e.g., other than a natural person), then the officer, director or other official so designated by such legal entity shall exercise such Owner's membership rights, as more particularly set forth herein and in the By-Laws.
- 6.2 Assignment. The share of a member in the funds and assets of the Association cannot be assigned, hypothecated or transferred in any manner except as an appurtenance to the Unit for which that share is held.
- 6.3 Voting. On all matters upon which the membership shall be entitled to vote, there shall be only one vote for each Unit. All votes shall be exercised or cast in the manner provided by the Declaration and By-Laws. Any person or entity owning more than one Unit shall be entitled to cast the aggregate number of votes attributable to all Units owned.
- 6.4 Meetings. The By-Laws shall provide for an annual meeting of members, and may make provision for regular and special meetings of members other than the annual meeting.

**ARTICLE 7**  
**TERM OF EXISTENCE**

The Association shall have perpetual existence, unless dissolved in accordance with applicable law.

**ARTICLE 8**  
**INCORPORATOR**

The name and address of the Incorporator of this Corporation is:

| <u>NAME</u>         | <u>ADDRESS</u>   |
|---------------------|--|
| James E. Albertelli | Albertelli & Associates, P.L.<br>330 A1A North, Suite 324<br>Ponte Vedra Beach, FL 32082 |

**ARTICLE 9**  
**OFFICERS**

The affairs of the Association shall be administered by the officers holding the offices designated in the By-Laws. The officers shall be elected by the Board of Directors of the Association at its first meeting following the annual meeting of the members of the Association and shall serve at the pleasure of the Board of Directors. The By-Laws may provide for the removal from office of officers, for filling vacancies and for the duties and qualifications of the officers. The names and addresses of the officers who shall serve until their successors are designated by the Board of Directors are as follows:

President:

|                     |   |
|---------------------|---|
| James E. Albertelli | 12171 Beach Boulevard<br>Jacksonville, FL 32246 |
|---------------------|---|

Vice President/Treasurer:

|             |   |
|-------------|---|
| Doris Myers | 12171 Beach Boulevard<br>Jacksonville, FL 32246 |
|-------------|---|

Secretary:

|             |   |
|-------------|---|
| Scott Auker | 12171 Beach Boulevard<br>Jacksonville, FL 32246 |
|-------------|---|

**ARTICLE 10**  
**DIRECTORS**

- 10.1 Number and Qualification. The property, business and affairs of the Association shall be managed by a board consisting of the number of directors determined in the manner provided by the By-Laws, but which shall consist of not less than three (3) directors. Directors need not be members of the Association.
- 10.2 Duties and Powers. All of the duties and powers of the Association existing under the Act, the Declaration, these Articles and the By-Laws shall be exercised exclusively by the Board of Directors, its agents, contractors or employees, subject only to approval by Unit Owners when such approval is specifically required.
- 10.3 Election; Removal. Directors of the Association shall be elected at the annual meeting of the members in the manner determined by and subject to the qualifications set forth in the By-Laws. Directors may be removed and vacancies on the Board of Directors shall be filled in the manner provided by the By-Laws.
- 10.4 Term of Developer's Directors. The Developer of the Condominium shall appoint the members of the first Board of Directors and their replacements who shall hold office for the periods described in the By-Laws.

10.5 First Directors. The names and addresses of the members of the first Board of Directors who shall hold office until their successors are elected and have taken office, as provided in the By-Laws, are as follows:

James E. Albertelli 12171 Beach Boulevard  
Jacksonville, FL 32246

Doris Myers 12171 Beach Boulevard  
Jacksonville, FL 32246

Scott Auker 12171 Beach Boulevard  
Jacksonville, FL 32246

10.6 Standards. A Director shall discharge his duties as a director, including any duties as a member of a Committee: in good faith; with the care an ordinary prudent person in a like position would exercise under similar circumstances; and in a manner reasonably believed to be in the best interests of the Association. Unless a Director has knowledge concerning a matter in question that makes reliance unwarranted, a Director, in discharging his duties, may rely on information, opinions, reports or statements, including financial statements and other data, if prepared or presented by: one or more officers or employees of the Association whom the Director reasonably believes to be reasonable and competent in the manners presented; legal counsel, public accountants or other persons as to matters the Director reasonably believes are within the persons' professional or expert competence; or a Committee of which the Director is not a member if the Director reasonably believes the Committee merits confidence. A Director is not liable for any action taken as a director, or any failure to take action, if he performed the duties of his office in compliance with the foregoing standards.

**ARTICLE 11**  
**INDEMNIFICATION**

11.1 Indemnitees. The Association shall indemnify any person who was, will be or is a party to any proceeding (other than an action by, or in the right of, the Association) by reason of the fact that he is or was a director, officer, employee or agent (each, an "Indemnitee") of the Association, against liability incurred in connection with such proceeding, including any appeal thereof, if he acted in good faith and in a manner he reasonably believed to be in, or not opposed to, the best interests of the Association and, with respect to any criminal action or proceeding, had no reasonable cause to believe his conduct was unlawful. The termination of any proceeding by judgment, order, settlement, or conviction or upon a plea of nolo contendere or its equivalent shall not, of itself, create a presumption that the person did not act in good faith and in a manner which he reasonably believed to be in, or not opposed to, the best interests of the Association or, with respect to any criminal action or proceeding, had reasonable cause to believe that his conduct was unlawful.

11.2 Indemnification. The Association shall indemnify any person, who was, will be or is a party to any proceeding, or any threat of same, by or in the right of the Association to procure a judgment in its favor by reason of the fact that he is or was a director, officer, employee, or agent of the Association against expenses and amounts paid in settlement not exceeding, in the judgment of the board of directors, the estimated expense of litigating the proceeding to conclusion, actually and reasonably incurred in connection with the defense or settlement of such proceeding, including any appeal thereof. Such indemnification shall be authorized if such person acted in good faith and in a manner he reasonably believed to be in, or not opposed to, the best interests of the Association, except that no indemnification shall be made under this Article 11 in respect of any claim, issue, or matter as to which such person shall have been adjudged to be liable unless, and only to the extent that, the court in which such proceeding was brought, or any other court of competent jurisdiction, shall determine upon application that, despite the adjudication of liability but in view of all circumstances of the case, such person is fairly and reasonably entitled to indemnity for such expenses which such court shall deem proper.

11.3 Indemnification for Expenses. To the extent that a director, officer, employee, or agent of the Association has been successful on the merits or otherwise in defense of any proceeding referred to in subsection 11.1 or 11.2, or in defense of any claim, issue, or matter therein, he shall be indemnified against expenses actually and reasonably incurred by him in connection therewith.

11.4 Determination of Applicability. Any indemnification under subsection 11.1 or subsection 11.2, unless pursuant to a determination by a court, shall be made by the Association only as authorized in the specific case upon a determination that indemnification of the director, officer, employee, or

agent is proper under the circumstances because he has met the applicable standard of conduct set forth in subsection 11.1 or subsection 11.2. Such determination shall be made:

- (a) By the Board of Directors by a majority vote of a quorum consisting of directors who were not parties to such proceeding;
  - (b) If such a quorum is not obtainable or, even if obtainable, by majority vote of a Committee duly designated by the Board of Directors (in which directors who are parties may participate) consisting solely of two or more Directors not at the time parties to the proceeding;
  - (c) By independent legal counsel:
    - 1. selected by the Board of Directors prescribed in paragraph 11.4(a) or the committee prescribed in paragraph 11.4(b); or
    - 2. if a quorum of the Directors cannot be obtained for paragraph 11.4(a) and the Committee cannot be designated under paragraph 11.4(b), selected by majority vote of the full Board of Directors (in which Directors who are parties may participate); or
  - (d) By a majority of the voting interests of the members of the Association who were not parties to such proceeding.
- 11.5 Determination Regarding Expenses. Evaluation of the reasonableness of expenses and authorization of indemnification shall be made in the same manner as the determination that indemnification is permissible. However, if the determination of permissibility is made by independent legal counsel, persons specified by paragraph 11.4(c) shall evaluate the reasonableness of expenses and may authorize indemnification.
- 11.6 Advancing Expenses. Expenses incurred by an officer or director in defending a civil or criminal proceeding, or the threat of same, may be paid by the Association in advance of the final disposition of such proceeding upon receipt of an undertaking by or on behalf of such director or officer to repay such amount if he is ultimately found not to be entitled to indemnification by the Association pursuant to this section. Expenses incurred by other employees and agents may be paid in advance upon such terms or conditions that the Board of Directors deems appropriate.
- 11.7 Exclusivity; Exclusions. The indemnification and advancement of expenses provided pursuant to this section are not exclusive, and the Association may make any other or further indemnification or advancement of expenses of any of its directors, officers, employees, or agents, under any bylaw, agreement, vote of shareholders or disinterested directors, or otherwise, both as to action in his official capacity and as to action in another capacity while holding such office. However, indemnification or advancement of expenses shall not be made to or on behalf of any director, officer, employee, or agent if a judgment or other final adjudication establishes that his actions, or omissions to act, were material to the cause of action so adjudicated and constitute:
- (a) A violation of the criminal law, unless the director, officer, employee, or agent had reasonable cause to believe his conduct was lawful or had no reasonable cause to believe his conduct was unlawful;
  - (b) A transaction from which the director, officer, employee, or agent derived an improper personal benefit; or
  - (c) Willful misconduct or a conscious disregard for the best interests of the Association in a proceeding by or in the right of the Association to procure a judgment in its favor or in a proceeding by or in the right of the members of the Association.
- 11.8 Continuing Effect. Indemnification and advancement of expenses as provided in this Article 11 shall continue as, unless otherwise provided when authorized or ratified, to a person who has ceased to be a director, officer, employee, or agent and shall inure to the benefit of the heirs, executors, and administrators of such a person, unless otherwise provided when authorized or ratified.
- 11.9 Application to Court. Notwithstanding the failure of the Association to provide indemnification, and despite any contrary determination of the Board or of the members in the specific case, a director, officer, employee, or agent of the Association who is or was a party to a proceeding may apply for indemnification or advancement of expenses, or both, to the court conducting the proceeding, to the circuit court, or to another court of competent jurisdiction. On receipt of an application, the court, after giving any notice that it considers necessary, may order indemnification and advancement of expenses, including expenses incurred in seeking court-ordered indemnification or advancement of expenses, if it determines that:

- (a) The director, officer, employee, or agent is entitled to mandatory indemnification under subsection 11.3, in which case the court shall also order the Association to pay the director reasonable expenses incurred in obtaining court-ordered indemnification or advancement of expenses;
- (b) The director, officer, employee, or agent is entitled to indemnification or advancement of expenses, or both, by virtue of the exercise by the Association of its power pursuant to subsection 11.7; or
- (c) The director, officer, employee, or agent is fairly and reasonably entitled to indemnification or advancement of expenses, or both, in view of all the relevant circumstances, regardless of whether such person met the standard of conduct set forth in subsection 11.1, subsection 11.2, or subsection 11.7. unless (a) a court of competent jurisdiction determines, after all available appeals have been exhausted or not pursued by the proposed indemnitee, that he did not act in good faith or acted in a manner he reasonably believed to be not in, or opposed to, the best interest of the Association, and, with respect to any criminal action or proceeding, that he had reasonable cause to believe his conduct was unlawful, and (b) such court further specifically determines that indemnification should be denied. The termination of any proceeding by judgment, order, settlement, conviction or upon a plea of nolo contendere or its equivalent shall not, of itself, create a presumption that the person did not act in good faith or did act in a manner which he reasonably believed to be not in, or opposed to, the best interest of the Association, and, with respect to any criminal action or proceeding, that he had reasonable cause to believe that his conduct was unlawful.

- 11.10 Definitions. For purposes of this Article 11, the term "expenses" shall be deemed to include attorneys' fees and related "out-of-pocket" expenses, including those for any appeals; the term "liability" shall be deemed to include obligations to pay a judgment, settlement, penalty, fine, and expenses actually and reasonably incurred with respect to a proceeding; the term "proceeding" shall be deemed to include any threatened, pending, or completed action, suit, or other type of proceeding, whether civil, criminal, administrative or investigative, and whether formal or informal; and the term "agent" shall be deemed to include a volunteer; the term "serving at the request of the Association" shall be deemed to include any service as a director, officer, employee or agent of the Association that imposes duties on, and which are accepted by, such persons.
- 11.11 Effect. The indemnification provided by this Article 11 shall not be deemed exclusive of any other rights to which those seeking indemnification may be entitled under any applicable law, agreement, or vote of members or otherwise.
- 11.12 Amendment. Anything to the contrary herein notwithstanding, no amendment to the provisions of this Article 11 shall be applicable as to any party eligible for indemnification hereunder who has not given his prior written consent to such amendment.

**ARTICLE 12**  
**BY-LAWS**

The first By-Laws of the Association shall be adopted by the Board of Directors and may be altered, amended or rescinded in the manner provided in the By-Laws and the Declaration.

**ARTICLE 13**  
**AMENDMENTS**

Amendments to these Articles shall be proposed and adopted in the following manner:

- 13.1 Notice. Notice of a proposed amendment shall be included in the notice of any meeting at which the proposed amendment is to be considered and shall be otherwise given in the time and manner provided in Chapter 617, Florida Statutes. Such notice shall contain the proposed amendment or a summary of the changes to be affected thereby.
- 13.2 Adoption. Amendments shall be proposed and adopted in the manner provided in Chapter 617, Florida Statutes and in the Act (the latter to control over the former to the extent provided for in the Act).
- 13.3 Limitation. No amendment shall make any changes in the qualifications for membership, nor in the voting rights or property rights of members, nor any changes in subsections 5.3, 5.4 or 5.5, without the approval in writing of all members and the joinder of all record owners of mortgages upon Units. No amendment shall be made that is in conflict with the Act, the Declaration or the By-Laws, nor shall any amendment make any changes which would in any way affect any of the rights, privileges, powers or options herein provided in favor of or reserved to the Developer

and/or Institutional First Mortgagees, unless the Developer and/or the Institutional First Mortgagees, as applicable, shall join in the execution of the amendment. No amendment to this paragraph 13.3 shall be effective.

- 13.4 Developer Amendments. Notwithstanding anything herein contained to the contrary, to the extent lawful, the Developer may amend these Articles consistent with the provisions of the Declaration allowing certain amendments to be effected by the Developer alone.
- 13.5 Recording. A copy of each amendment shall be filed with the Secretary of State pursuant to the provisions of applicable Florida law, and a copy certified by the Secretary of State shall be recorded in the public records of Duval County, Florida with an identification on the first page thereof of the book and page of said public records where the Declaration was recorded which contains, as an exhibit, the initial recording of these Articles.

**ARTICLE 14**  
**INITIAL REGISTERED OFFICE;**  
**ADDRESS AND NAME OF REGISTERED AGENT**

Until changed Albertelli & Associates, P.L. shall be the registered agent of the Association and the registered office shall be at 330 A1A North, Suite 324, Ponte Vedra Beach, FL 32082.

IN WITNESS WHEREOF, the aforesaid incorporator has hereunto set his hand this \_\_\_ day of \_\_\_\_\_, 2005.

\_\_\_\_\_  
James E. Albertelli, Incorporator



CERTIFICATE DESIGNATING PLACE OF BUSINESS OR DOMICILE FOR THE SERVICE OF PROCESS  
WITHIN THIS STATE, NAMING AGENT UPON WHOM PROCESS MAY BE SERVED.

In compliance with the laws of Florida, the following is submitted:

First -- That desiring to organize under the laws of the State of Florida with its principal office, as indicated in the foregoing articles of incorporation, in the County of Duval, State of Florida, the Association named in the said articles has named Albertelli & Associates, P.L., 330 A1A North, Suite 324, Ponte Vedra Beach, FL 32082 as its statutory registered agent.

Having been named the statutory agent of said Association at the place designated in this certificate, I am familiar with the obligations of that position, and hereby accept the same and agree to act in this capacity, and agree to comply with the provisions of Florida law relative to keeping the registered office open.

\_\_\_\_\_  
Albertelli & Associates, P.L., registered agent

DATED this \_\_\_\_ day of \_\_\_\_\_, 2005.



CERTIFICATE DESIGNATING PLACE OF BUSINESS OR DOMICILE FOR THE SERVICE OF PROCESS  
WITHIN THIS STATE, NAMING AGENT UPON WHOM PROCESS MAY BE SERVED.

In compliance with the laws of Florida, the following is submitted:

First -- That desiring to organize under the laws of the State of Florida with its principal office, as indicated in the foregoing articles of incorporation, in the County of Duval, State of Florida, the Association named in the said articles has named Albertelli & Associates, P.L., 330 A1A North, Suite 324, Ponte Vedra Beach, FL 32082 as its statutory registered agent.

Having been named the statutory agent of said Association at the place designated in this certificate, I am familiar with the obligations of that position, and hereby accept the same and agree to act in this capacity, and agree to comply with the provisions of Florida law relative to keeping the registered office open.

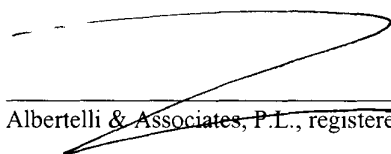
  
Albertelli & Associates, P.L., registered agent

DATED this 16 day of February, 2006.

**EXHIBIT 6**

**MONTEREY AT BEACH BOULEVARD, A CONDOMINIUM**

**GUARANTEED ASSESSMENT AMOUNTS**

| <u>Unit Type</u> | <u>Monthly Dues</u> | <u>Annual Dues</u> |
|------------------|---------------------|--------------------|
| A                | \$116.29            | \$1,395.48         |
| B                | \$170.56            | \$2,046.72         |
| C                | \$244.21            | \$2,930.52         |
| D                | \$251.96            | \$3,023.52         |
| E                | \$161.45            | \$1,937.40         |
| F                | \$187.03            | \$2,244.36         |
| G                | \$199.82            | \$2,397.84         |
| H                | \$225.41            | \$2,704.92         |
| I                | \$219.59            | \$2,635.08         |
| J                | \$245.18            | \$2,942.16         |
| K                | \$258.16            | \$3,097.92         |
| L                | \$283.74            | \$3,404.88         |
| M                | \$245.37            | \$2,944.44         |
| N                | \$270.95            | \$3,251.40         |
| O                | \$272.31            | \$3,267.72         |
| P                | \$297.70            | \$3,572.40         |

The following is a list of Units by Unit Type:

**Building 1:**

| <u>Unit Type</u> | <u>Unit Nos.</u> |
|------------------|------------------|
|                  |                  |

|   |               |
|---|---------------|
| A |               |
| B |               |
| C | 101, 102, 103 |
| D |               |
| E |               |
| F |               |
| G |               |
| H |               |
| I |               |
| J |               |
| K |               |
| L |               |
| M |               |
| N |               |
| O |               |
| P | 104           |

**Building 2:**

| <u>Unit Type</u> | <u>Unit Nos.</u>             |
|------------------|------------------------------|
| A                |                              |
| B                |                              |
| C                | 201, 202, 203, 204, 205, 206 |
| D                |                              |
| E                |                              |

|   |  |
|---|--|
| F |  |
| G |  |
| H |  |
| I |  |
| J |  |
| K |  |
| L |  |
| M |  |
| N |  |
| O |  |

**Building 3:**

| <u>Unit Type</u> | <u>Unit Nos.</u>                       |
|------------------|--|
| A                |  |
| B                |  |
| C                | 301, 302, 303, 304, 305, 306, 307, 308 |
| D                |  |

|   |  |
|---|--|
| E |  |
| F |  |
| G |  |
| H |  |
| I |  |
| J |  |
| K |  |
| L |  |
| M |  |
| N |  |
| O |  |

**Building 4:**

| <u>Unit Type</u> | <u>Unit Nos.</u>             |
|------------------|------------------------------|
| A                |                              |
| B                |                              |
| C                | 401, 402, 403, 404, 405, 406 |
| D                |                              |
| E                |                              |
| F                |                              |
| G                |                              |
| H                |                              |
| I                |                              |
| J                |                              |
| K                |                              |

|   |  |
|---|--|
| L |  |
| M |  |
| N |  |
| O |  |

**Building 5:**

| <u>Unit Type</u> | <u>Unit Nos.</u>   |
|------------------|--|
| A                | 501, 502, 503, 504, 505, 506, 507, 508, 509, 510, 511, 512 |
| B                |  |
| C                |  |
| D                |  |
| E                |  |
| F                |  |
| G                |  |
| H                |  |
| I                |  |
| J                |  |
| K                |  |
| L                |  |
| M                |  |
| N                |  |
| O                |  |

**Building 6:**

| <u>Unit Type</u> | <u>Unit Nos.</u> |
|------------------|------------------|
|                  |                  |



|          |  |
|----------|--|
| <b>A</b> |  |
| <b>B</b> | 601, 602, 603, 604, 605, 606, 607, 608 |
| <b>C</b> |  |
| <b>D</b> |  |
| <b>E</b> |  |
| <b>F</b> |  |
| <b>G</b> |  |
| <b>H</b> |  |
| <b>I</b> |  |
| <b>J</b> |  |
| <b>K</b> |  |
| <b>L</b> |  |
| <b>M</b> |  |
| <b>N</b> |  |
| <b>O</b> |  |

**Building 7:**

| <b><u>Unit Type</u></b> | <b><u>Unit Nos.</u></b>                |
|-------------------------|--|
| <b>A</b>                |  |
| <b>B</b>                | 701, 702, 703, 704, 705, 706, 707, 708 |
| <b>C</b>                |  |
| <b>D</b>                |  |
| <b>E</b>                |  |

|   |  |
|---|--|
| F |  |
| G |  |
| H |  |
| I |  |
| J |  |
| K |  |
| L |  |
| M |  |
| N |  |
| O |  |

**Building 8:**

| <u>Unit Type</u> | <u>Unit Nos.</u>                       |
|------------------|--|
| A                |  |
| B                | 801, 802, 803, 804, 805, 806, 807, 808 |
| C                |  |
| D                |  |
| E                |  |
| F                |  |
| G                |  |
| H                |  |
| I                |  |
| J                |  |
| K                |  |

|   |  |
|---|--|
| L |  |
| M |  |
| N |  |
| O |  |

**Building 9:**

| <u>Unit Type</u> | <u>Unit Nos.</u>                       |
|------------------|--|
| A                |  |
| B                | 901, 902, 903, 904, 905, 906, 907, 908 |
| C                |  |
| D                |  |
| E                |  |
| F                |  |
| G                |  |
| H                |  |
| I                |  |
| J                |  |
| K                |  |
| L                |  |
| M                |  |
| N                |  |
| O                |  |

**Building 10:**

| <u>Unit Type</u> | <u>Unit Nos.</u> |
|------------------|------------------|
|                  |                  |

|          |  |
|----------|--|
| <b>A</b> | 1001, 1002, 1003, 1004, 1005, 1006, 1007, 1008, 1009, 1010, 1011, 1012 |
| <b>B</b> |  |
| <b>C</b> |  |
| <b>D</b> |  |
| <b>E</b> |  |
| <b>F</b> |  |
| <b>G</b> |  |
| <b>H</b> |  |
| <b>I</b> |  |
| <b>J</b> |  |
| <b>K</b> |  |
| <b>L</b> |  |
| <b>M</b> |  |
| <b>N</b> |  |
| <b>O</b> |  |

**Building 11:**

| <b><u>Unit Type</u></b> | <b><u>Unit Nos.</u></b>  |
|-------------------------|--|
| <b>A</b>                | 1101, 1102, 1103, 1104, 1105, 1106, 1107, 1108, 1109, 1110, 1111, 1112 |
| <b>B</b>                |  |
| <b>C</b>                |  |
| <b>D</b>                |  |
| <b>E</b>                |  |
| <b>F</b>                |  |
| <b>G</b>                |  |
| <b>H</b>                |  |

|   |  |
|---|--|
| I |  |
| J |  |
| K |  |
| L |  |
| M |  |
| N |  |
| O |  |

**Building 12:**

| <u>Unit Type</u> | <u>Unit Nos.</u>                               |
|------------------|--|
| A                |  |
| B                | 1201, 1202, 1203, 1204, 1205, 1206, 1207, 1208 |
| C                |  |
| D                |  |
| E                |  |
| F                |  |
| G                |  |
| H                |  |
| I                |  |
| J                |  |
| K                |  |
| L                |  |
| M                |  |
| N                |  |
| O                |  |

**Building 13:**

| <u>Unit Type</u> | <u>Unit Nos.</u>       |
|------------------|------------------------|
| A                |                        |
| B                |                        |
| C                |                        |
| D                | 1302, 1303, 1304, 1305 |
| E                |                        |
| F                |                        |
| G                |                        |
| H                |                        |
| I                |                        |
| J                |                        |
| K                |                        |
| L                |                        |
| M                |                        |
| N                |                        |
| O                | 1301, 1306, 1307       |

**Building 14:**

| <u>Unit Type</u> | <u>Unit Nos.</u> |
|------------------|------------------|
| A                |                  |
| B                |                  |
| C                |                  |
| D                |                  |
| E                | 1416, 1426       |
| F                | 1415, 1425,      |

|          |                                    |
|----------|------------------------------------|
| <b>G</b> |                                    |
| <b>H</b> |                                    |
| <b>I</b> | 1411, 1414, 1417, 1421, 1424, 1427 |
| <b>J</b> | 1412, 1413, 1418, 1422, 1423, 1428 |
| <b>K</b> |                                    |
| <b>L</b> |                                    |
| <b>M</b> |                                    |
| <b>N</b> |                                    |
| <b>O</b> |                                    |

**Building 15:**

| <u>Unit Type</u> | <u>Unit Nos.</u>       |
|------------------|------------------------|
| <b>A</b>         |                        |
| <b>B</b>         |                        |
| <b>C</b>         |                        |
| <b>D</b>         |                        |
| <b>E</b>         | 1516, 1526             |
| <b>F</b>         | 1515, 1525             |
| <b>G</b>         | 1531, 1536, 1537       |
| <b>H</b>         | 1532, 1535, 1538       |
| <b>I</b>         | 1514, 1524             |
| <b>J</b>         | 1513, 1523             |
| <b>K</b>         | 1534                   |
| <b>L</b>         | 1533                   |
| <b>M</b>         | 1511, 1517, 1521, 1527 |
| <b>N</b>         | 1512, 1518, 1522, 1528 |

|   |  |
|---|--|
| O |  |
|---|--|

**Building 16:**

| <u>Unit Type</u> | <u>Unit Nos.</u>       |
|------------------|------------------------|
| A                |                        |
| B                |                        |
| C                |                        |
| D                |                        |
| E                | 1616, 1626             |
| F                | 1615, 1625             |
| G                | 1631, 1636, 1637       |
| H                | 1632, 1635, 1638       |
| I                | 1614, 1624             |
| J                | 1613, 1623             |
| K                | 1634                   |
| L                | 1633                   |
| M                | 1611, 1617, 1621, 1627 |
| N                | 1612, 1618, 1622, 1628 |
| O                |                        |

**Building 17:**

| <u>Unit Type</u> | <u>Unit Nos.</u> |
|------------------|------------------|
| A                |                  |
| B                |                  |
| C                |                  |
| D                |                  |



|          |                                    |
|----------|------------------------------------|
| <u>E</u> | 1716, 1726                         |
| <u>F</u> | 1715, 1725                         |
| <u>G</u> |                                    |
| <u>H</u> |                                    |
| <u>I</u> | 1711, 1714, 1717, 1721, 1724, 1727 |
| <u>J</u> | 1712, 1713, 1718, 1722, 1723, 1728 |
| <u>K</u> |                                    |
| <u>L</u> |                                    |
| <u>M</u> |                                    |
| <u>N</u> |                                    |
| <u>O</u> |                                    |

**Building 18:**

| <u>Unit Type</u> | <u>Unit Nos.</u>                   |
|------------------|------------------------------------|
| <u>A</u>         |                                    |
| <u>B</u>         |                                    |
| <u>C</u>         |                                    |
| <u>D</u>         |                                    |
| <u>E</u>         | 1816, 1826                         |
| <u>F</u>         | 1815, 1825                         |
| <u>G</u>         |                                    |
| <u>H</u>         |                                    |
| <u>I</u>         | 1811, 1814, 1817, 1821, 1824, 1827 |
| <u>J</u>         | 1812, 1813, 1818, 1822, 1823, 1828 |
| <u>K</u>         |                                    |
| <u>L</u>         |                                    |

|          |  |
|----------|--|
| <u>M</u> |  |
| <u>N</u> |  |
| <u>O</u> |  |

**Building 19:**

| <u>Unit Type</u> | <u>Unit Nos.</u>                   |
|------------------|------------------------------------|
| <u>A</u>         |                                    |
| <u>B</u>         |                                    |
| <u>C</u>         |                                    |
| <u>D</u>         |                                    |
| <u>E</u>         | 1916, 1926,                        |
| <u>F</u>         | 1915, 1925                         |
| <u>G</u>         |                                    |
| <u>H</u>         |                                    |
| <u>I</u>         | 1911, 1914, 1917, 1921, 1924, 1927 |
| <u>J</u>         | 1912, 1913, 1918, 1922, 1923, 1928 |
| <u>K</u>         |                                    |
| <u>L</u>         |                                    |
| <u>M</u>         |                                    |
| <u>N</u>         |                                    |
| <u>O</u>         |                                    |